

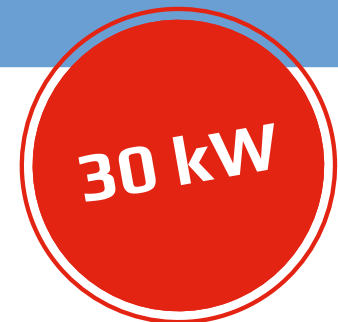

Elektro-Automatik

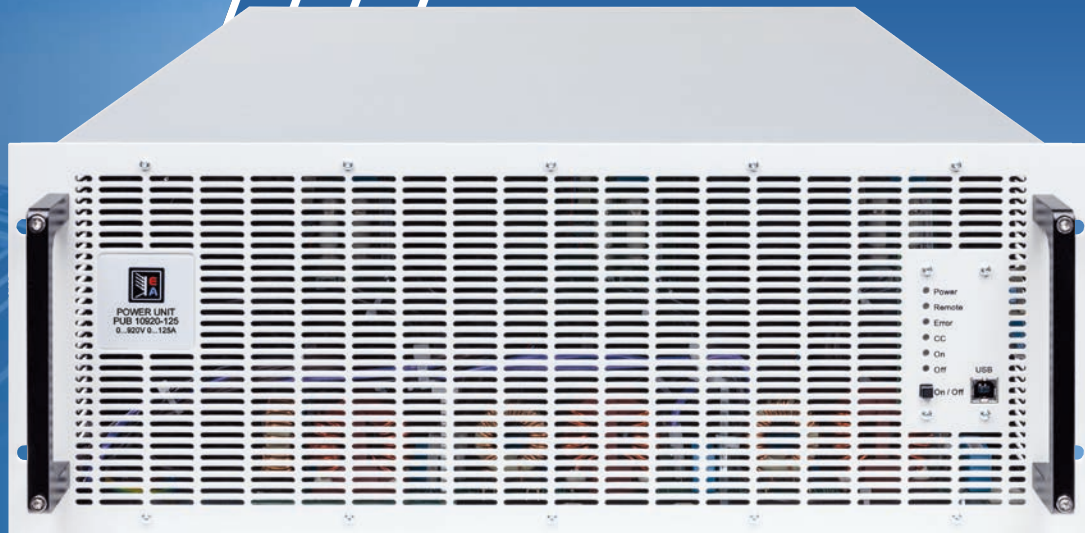

MANUAL

EA-PUB 10000 4U

Programmable bidirectional
DC Power Supplies

TABLE OF CONTENTS

1. General

1.1	About this document	5
1.1.1	Retention and use	5
1.1.2	Copyright	5
1.1.3	Validity	5
1.1.4	Symbols and warnings in this document	5
1.2	Warranty	5
1.3	Limitation of liability	5
1.4	Disposal of equipment	6
1.5	Product key	6
1.6	Intended usage	7
1.6.1	Symbols and warnings on the device	7
1.7	Safety	8
1.7.1	Safety notices	8
1.7.2	Responsibility of the operator	9
1.7.3	Requirements to the user	9
1.7.4	Responsibility of the user	9
1.7.5	Alarm signals	10
1.7.6	Functionality test	10
1.8	Technical Data	11
1.8.1	Approved operating conditions	11
1.8.2	General technical data	11
1.8.3	Specific technical data	12
1.8.4	Views	15
1.8.5	Control elements	20
1.9	Construction and function	21
1.9.1	General description	21
1.9.2	Block diagram	21
1.9.3	Scope of delivery	22
1.9.4	Accessories	22
1.9.5	Options	22
1.9.6	The control panel (HMI)	23
1.9.7	USB port (rear side)	24
1.9.8	Interface module slot	24
1.9.9	Analog interface	24
1.9.10	“Share BUS” connector	25
1.9.11	“Sense” connector (remote sensing)	25
1.9.12	Master-Slave bus	25
1.9.13	Ethernet port	26
1.9.14	Water cooling	26

2. Installation & commissioning

2.1	Transport and storage	27
2.1.1	Transport	27
2.1.2	Packaging	27
2.1.3	Storage	27
2.2	Unpacking and visual check	27
2.3	Installation	27

2.3.1	Safety procedures before installation and use	27
2.3.2	Preparation	28
2.3.3	Installing the device	30
2.3.4	Connection to water supply (WC models)	31
2.3.5	Connection to AC supply	33
2.3.6	Connection to DC loads or DC sources	35
2.3.7	Grounding of the DC terminal	36
2.3.8	Connection of remote sensing	37
2.3.9	Installation of an interface module	38
2.3.10	Connection of the analog interface	39
2.3.11	Connection of the Share bus	39
2.3.12	Connection of the USB port (rear side)	39
2.3.13	Initial commission	39
2.3.14	Commission after a firmware update or a long period of non-use	39

3. Operation and application

3.1	Terms	40
3.2	Important notes	40
3.2.1	Personal safety	40
3.2.2	General	40
3.3	Operating modes	40
3.3.1	Voltage regulation / Constant voltage	40
3.3.2	Current regulation / constant current / current limiting	41
3.3.3	Power regulation / constant power / power limiting	42
3.3.4	Internal resistance regulation (source mode)	42
3.3.5	Resistance regulation / constant resistance (sink mode)	43
3.3.6	Sink-source mode switching	43
3.3.7	Dynamic characteristics and stability criteria	43
3.4	Alarm conditions	44
3.4.1	Power Fail	44
3.4.2	Overtemperature	44
3.4.3	Overvoltage protection	44
3.4.4	Overcurrent protection	44
3.4.5	Overpower protection	44
3.4.6	Safety OVP	45
3.4.7	Share bus fail	45
3.5	Manual operation	46
3.5.1	Switching on the device	46
3.5.2	Switching the device off	46
3.5.3	Switching the DC output on or off	46
3.6	Remote control	47
3.6.1	General	47
3.6.2	Remote control via digital interface	47

3.6.3	Interface monitoring	49
3.6.4	Remote control via the analog interface	50
3.7	Alarms and monitoring	55
3.7.1	Definition of terms	55
3.7.2	Device alarm and event handling	55
3.8	Other applications	57
3.8.1	Parallel operation in master-slave (MS)	57
3.8.2	Series connection	61
3.8.3	SEMI F47	61
4.	Service and maintenance	
4.1	Maintenance / cleaning	62
4.1.1	Battery replacement	62
4.2	Fault finding / diagnosis / repair	62
4.2.1	Firmware updates	62
4.2.2	Trouble-shooting device problems	63
5.	Contact and support	
5.1	General	64
5.2	Contact options	64

Attention! The part of this document that deals with the handling of features on the control panel is only valid for devices with firmwares "KE: 3.06", "HMI: 3.04" and "DR: 1.0.2.20" or higher.

1. General

1.1 About this document

1.1.1 Retention and use

This document is to be kept in the vicinity of the equipment for future reference and explanation of the operation of the device. This document is to be delivered and kept with the equipment in case of change of location and/or user.

The most recent issue of this document can be found online, on our website.

1.1.2 Copyright

Modification and partial or complete usage of this PDF document for other purposes as intended are forbidden and breach may lead to legal process.





1.1.3 Validity

This manual is valid for the following equipment and its variants:

Model	Model	Model	Model
EA-PUB 10010-1000 4U	EA-PUB 10200-420 4U	EA-PUB 10750-120 4U	EA-PUB 11500-60 4U
EA-PUB 10060-1000 4U	EA-PUB 10360-240 4U	EA-PUB 10920-125 4U	EA-PUB 12000-40 4U
EA-PUB 10080-1000 4U	EA-PUB 10500-180 4U	EA-PUB 11000-80 4U	

1.1.4 Symbols and warnings in this document

Warning and safety notices as well as general notices in this document are shown in a box with a symbol as follows. The symbols are also valid, where placed, also to mark specific spots on the device:

	Symbol for a life threatening danger (electric shock hazard)
	Symbol for risk (of damage to the equipment). If placed on the device it requests the user to read the operating guide prior to start operation.
	Symbol for general safety notices (instructions and damage protection bans) or important information for operation
	<i>Symbol for general notices</i>

1.2 Warranty

EA Elektro-Automatik guarantees the functional competence of the applied technology and the stated performance parameters. The warranty period begins with the delivery of free from defects equipment.

Terms of guarantee are included in the general terms and conditions (TOS) of EA Elektro-Automatik.

1.3 Limitation of liability

All statements and instructions in this manual are based on current norms and regulations, up-to-date technology and our long term knowledge and experience. The manufacturer accepts no liability for losses due to:

- Usage for purposes other than designed
- Use by untrained personnel
- Rebuilding by the customer
- Technical changes
- Use of not authorized spare parts

The actual delivered device(s) may differ from the explanations and diagrams given here due to latest technical changes or due to customized models with the inclusion of additionally ordered options.

1.4 Disposal of equipment

A piece of equipment which is intended for disposal must, according to European laws and regulations (ElektroG, WEEE) be returned to the manufacturer for scrapping, unless the person operating the piece of equipment or another, delegated person is conducting the disposal. Our equipment falls under these regulations and is accordingly marked with the following symbol:



The device contains a Lithium battery cell. Disposal of that battery follows the above stated rule or specific local regulations.

1.5 Product key

Decoding of the product description on the label, using an example:

EA-PUB 10080 - 1000 4U xxx

	Options and special versions: WC = Water cooling installed
	Construction (only stated on type label): 4U = 19" frame with 4 height units
	Maximum current of the device in Ampere
	Maximum voltage of the device in Volt ("10080" = 80 V)
	Series: 10 = Series 10000
	Type identification: PSB = Power Unit Bidirectional

1.6 Intended usage

The equipment is intended to be used only as a variable voltage and current source or only as a variable current sink. Furthermore it's only intended to be used installed and operated in suitable equipment (19" rack or similar), together with a rigid, non-retractable AC supply connection.





Typical application for a voltage source is DC power supply to any relevant user, including when used as battery charger to test charge various battery types, and for current sinks the replacement of an ohmic resistor by an adjustable electronic DC load in order to load relevant voltage and current sources of any type.

Additionally to the functionality of the equipment as source or sink of electrical energy on the DC side, all models in this series are also so-called recuperating devices and thus not just drain energy on the AC side, but also source energy when being sinks on the DC side. This is where the term "bidirectional" comes from. In sink mode the devices become energy recoverers, but are not defined or considered as energy generation equipment.



- Claims of any sort due to damage caused by non-intended usage will not be accepted
- All damage caused by non-intended usage is solely the responsibility of the operator

1.6.1 Symbols and warnings on the device

Decal	Explanation
 <div style="border: 1px solid black; padding: 5px;"> <p>⚠ DANGER RISK OF ELECTRIC SHOCK Disconnect all sources of supply prior to servicing.</p> </div>	This warning is primarily related to the reconfiguration of the device on the DC terminal which, for safety reasons, requires to also cut the device from AC (external main switch). The same applies to disconnection and reconnection of the AC terminal.
 <div style="border: 1px solid black; padding: 5px;"> <p>⚠ DANGER Capacitors on DC, storing voltage! Discharge for 10 sec then ground before working.</p> </div>	Even after disconnection of the DC terminal from an external source there can still be dangerous voltage potential present between the DC terminal poles and/or between DC and the enclosure. For safety reasons the DC terminal must be short-circuited after the capacitors have been discharged and it must also be grounded, i. e. connected to PE.
 <div style="border: 1px solid black; padding: 5px;"> <p>⚠ WARNING ELECTRICAL HAZARDS Authorized personnel only.</p> </div>	There can always be a voltage potential on metallic, openly touchable parts on electrical devices, though the voltage level may not be hazardous. Caution is still advisable, as these potential can still cause mild electrical shocks or sparking.
 <div style="border: 1px solid black; padding: 5px;"> <p>⚠ WARNING Read and understand the operating guide before using this device. Non-adherence of the instructions in the operating guide can result in serious injury or death.</p> </div>	This is valid for any use of the device.

Mortal danger - Hazardous voltage



- **Electrical equipment operation means that some parts accessible on the outside of the device can be under high voltage. Therefore all parts under voltage must be covered during operation! This basically applies to all models, except for the 10 V and 60 V models according to SELV.**
- **The DC terminal is isolated from the AC input and not connected to ground internally. Hence there can be dangerous potential between the DC poles and PE, for instance caused by a connected external source application. Due to charged capacitors this could even be true if the DC output or the device are already switched off.**
- **Do not insert any object, particularly metallic, through the ventilator slots!**
- **For every reconfiguration on the AC or DC connectors, specifically those which can have a dangerous voltage potential, the device must be cut completely from the AC supply (main switch on the distant end of the AC cable); it doesn't suffice to only use the power switch on the front**
- **Always follow 5 safety rules when working with electric devices:**
 - **Disconnect completely**
 - **Secure against reconnection**
 - **Verify that the system is dead**
 - **Carry out earthing and short-circuiting**
 - **Provide protection from adjacent live parts**



- Avoid any use of liquids near the equipment. Protect the device from wet, damp and condensation.
- Do not connect external power sources with reversed polarity to the DC terminal! The equipment will be damaged, even when completely powered off.
- Never connect external power sources to the DC terminal that can generate a higher voltage than the rated voltage of the device!
- Never insert a network cable which is connected to Ethernet or its components into the master-slave sockets on the rear side of the device!



- The equipment must only be used as intended
- The equipment is only approved for use within the connection limits stated on the product label.
- ESD regulations must be applied when plugging interface cards or modules into the relative slot
- Interface cards or modules may only be attached or removed after the device is switched off. It's not necessary to open the device.
- Always configure the various protecting features against overcurrent, overvoltage etc. for sensitive loads to what the target application requires!
- When operating the device as electronic load: always make sure that the energy recovery can feed back the inverted energy and that it does not switch to isolated operation. For situations of isolated operation a supervision device (grid protection) has to be installed
- It's not allowed to run the device on AC sources such as generators or UPS equipment. It must only be connected to a power grid!

1.7.2 Responsibility of the operator

Operator is any natural or legal person who uses the equipment or delegates the usage to a third party, and is responsible during its usage for the safety of the user, other personnel or third parties.

The equipment is in industrial operation. Therefore the operators are governed by the legal safety regulations. Alongside the warning and safety notices in this manual the relevant safety, accident prevention and environmental regulations must also be applied. In particular the operator has to

- be acquainted with the relevant job safety requirements
- identify other possible dangers arising from the specific usage conditions at the work station via a risk assessment
- introduce the necessary steps in the operating procedures for the local conditions
- regularly control that the operating procedures are current
- update the operating procedures where necessary to reflect changes in regulation, standards or operating conditions.
- define clearly and unambiguously the responsibilities for operation, maintenance and cleaning of the equipment.
- ensure that all employees who use the equipment have read and understood the manual. Furthermore the users are to be regularly schooled in working with the equipment and the possible dangers.
- provide all personnel who work with the equipment with the designated and recommended safety equipment

Furthermore, the operator is responsible for ensuring that the device is at all times technically fit for use.

1.7.3 Requirements to the user

Any activity with equipment of this type may only be performed by persons who are able to work correctly and reliably and satisfy the requirements of the job.

- Persons whose reaction capability is negatively influenced by e.g. drugs, alcohol or medication may not operate the equipment.
- Age or job related regulations valid at the operating site must always be applied.



Danger for unqualified users

Improper operation can cause person or object damage. Only persons who have the necessary training, knowledge and experience may use the equipment.

The group of people allowed to operate the equipment is additionally limited to:

Delegated persons: these are persons who have been properly and demonstrably instructed in their tasks and the attendant dangers.

Qualified persons: these are persons who are able through training, knowledge and experience as well as knowledge of the specific details to carry out all the required tasks, identify dangers and avoid personal and other risks.

1.7.4 Responsibility of the user

The equipment is in industrial operation. Therefore the operators are governed by the legal safety regulations. Alongside the warning and safety notices in this manual the relevant safety, accident prevention and environmental regulations must also be applied. In particular the users of the equipment:

- must be informed of the relevant job safety requirements
- must work to the defined responsibilities for operation, maintenance and cleaning of the equipment
- before starting work must have read and understood the operating manual

1.7.5 Alarm signals

The equipment offers various possibilities for signaling alarm conditions, however, not for danger situations. The signals are optical (via an LED on the control panel), electronic (status output of the analog interface) and digitally readable status bits. All alarms will cause the device to switch off the DC terminal. For details about the different alarms refer to section «3.4 Alarm conditions».

The meaning of the signals is as follows:

Signal OT (OverTemperature)	<ul style="list-style-type: none"> Overheating of the device DC terminal will be switched off Non-critical
Signal OVP / SOVP (OverVoltage)	<ul style="list-style-type: none"> Overvoltage shutdown of the DC terminal due to high voltage entering the device or generated by the device itself due to a defect Critical! The device and/or the load could be damaged
Signal OC (OverCurrent)	<ul style="list-style-type: none"> Shutdown of the DC terminal due to excess of the preset limit Non-critical, protects the load or source from excessive current consumption
Signal OPP (OverPower)	<ul style="list-style-type: none"> Shutdown of the DC terminal due to excess of the preset limit Non-critical, protects the load or source from excessive power consumption
Signal PF (Power Fail)	<ul style="list-style-type: none"> DC terminal shutdown due to AC undervoltage or defect in the AC section Critical on overvoltage! AC section could be damaged
Signal MSP (Master-Slave Protection)	<ul style="list-style-type: none"> DC terminal shutdown due to communication problems on the master-slave bus Non-critical
Signal SF (Share Bus Fail)	<ul style="list-style-type: none"> DC terminal shutdown due to signal distortion on the Share bus Non-critical

1.7.6 Functionality test

The operator of the device must decide when to check the device for correct functionality, by whom and how often. The when could either be before every use or after it has been relocated or reconfigured or perhaps in a defined interval.



Should the set values not be adjustable as instructed below it could simply be due to adjustment limits interfering. When reaching a limit adjusting value can't be signaled by the device. In remote control an invalid value would be rejected, together with an error message.

The test procedure would always be like this:

1. Disconnect all cables (DC, Sense, Share bus, analog interface, USB), except for AC.
2. Connect a suitable voltage meter to the DC terminal.
3. Switch the device on. Adjust a voltage of 10% U_{Nom} using remote control via the front or rear USB port while the current and power set values for source mode should be at maximum and those for sink mode at 0. Then switch the DC output on and verify with the multimeter that the adjusted voltage is available on the DC terminal. Also compare it to the actual voltage value read via remote command query.
4. Repeat the same thing at 100% U_{Nom} .
5. Switch the DC output off and bridge the DC terminal with a cable or copper rails of suitable current capability of at least I_{Nom} . If available, put a current measuring device (transducer, current probe).
6. Adjust the current for source mode to 10% I_{Nom} , switch the DC output on and measure the current with the external measuring device, if available, and compare to the actual current measured by the device which can be read via remote query command or at least compare the read actual current with the set value.
7. Repeat the same thing at 100% I_{Nom} .

Only if the current and voltage are supplied by the device as adjustable in the range of 0-100% FS, the device can be considered as correctly operational.

1.8 Technical Data

1.8.1 Approved operating conditions

1.8.1.1 Ambiance

The allowed ambient temperature range for operation is 0 °C (32 °F) to 50 °C (122 °F). During storage or transport, the allowed range extends to -20 °C (-4 °F) to 70 °C (158 °F). In case water condensation occurred due to transport, the device must be acclimatized prior to operation for at least 2 hours, ideally in a place with good air circulation.

The device is intended to be operation in dry rooms. It must not be exposed or operated to extreme dust, high air humidity, danger of explosion and aggressive chemicals polluting the air. The operating position isn't arbitrary (see «2.3.3 Installing the device»),but in any case it requires a sufficient air circulation. The device is allowed to be operated in altitude up to 2000 m (approx. 6,560 ft) above sea level. Technical specifications (here: ratings), when given with tolerance, are valid for a unit warmed up for at least 30 minutes and for an ambient temperature of 23 °C (73 °F). Specifications without tolerance are typical values from an average device.

1.8.1.2 Cooling

Power dissipated inside the device heats up air circulating through the device. With the air-cooled versions a fan at the end of an air flow channel, in which a cooling block is placed, pulls the air through the device. Entry is on the front, exhaust at the back. Depending on the internal temperature, the fan speed is automatically regulated up or down, whereas a certain minimum speed is maintained because some internal components even heat up when the device is idle.

Dust in the air can obstruct the air flow with time, thus it's important to keep the air flow unimpeded at least outside of the device be leaving sufficient room behind it. Since it's usually installed inside cabinets, the cabinet doors are required to be meshed.

At the same time, the ambient temperature should be kept at low levels, perhaps by external means such as an air condition. Should the device heat up internally and the cooling block temperature exceed 80 °C (160 °F), the device will protect itself from overheating by automatically switching off the power stage. It could then only continue to operate and switch the power stage on again after cooling down for some time.

For the water-cooled versions, water is the main cooling agent, flowing through the internal cooling blocks. The air inside the almost hermetically body circulates, engaged by fans, to cool the remaining components not sitting on the cooling blocks, but heat up over time.

1.8.2 General technical data

Display: 6 LED with different colors

Controls: 1 pushbutton

1.8.3 Specific technical data

General specifications	
AC input	
Voltage, Phases	380 V - 480 V $\pm 10\%$, 3ph AC (208 V - 240 V $\pm 10\%$, 3ph AC with derating to 18 kW)
Frequency	45 - 65 Hz
Power factor	ca. 0.99
Leakage current	<10 mA
Phase current	≤ 56 A @ 400 V AC
Overvoltage category	2
DC output static	
Load regulation CV	$\leq 0.05\%$ FS (0 - 100% load, constant AC input voltage and constant temperature)
Line regulation CV	$\leq 0.01\%$ FS (380 V - 480 V $\pm 10\%$ AC input voltage, constant load and constant temperature)
Stability CV	$\leq 0.02\%$ FS (during 8 h of operation, after 30 minutes warm-up, at constant AC input voltage, load and temperature)
Temperature coefficient CV	≤ 30 ppm/ $^{\circ}$ C (after 30 minutes of warm-up)
Compensation (remote sense)	$\leq 5\%$ $U_{Nominal}$
Load regulation CC	$\leq 0.1\%$ FS (0 - 100% load, constant AC input voltage and constant temperature)
Line regulation CC	$\leq 0.01\%$ FS (380 V - 480 V $\pm 10\%$ AC input voltage, constant load and constant temperature)
Stability CC	$\leq 0.02\%$ FS (during 8 h of operation, after 30 minutes warm-up, at constant AC input voltage, load and temperature)
Temperature coefficient CC	≤ 50 ppm/ $^{\circ}$ C (after 30 minutes of warm-up)
Load regulation CP	$\leq 0.3\%$ FS (0 - 100% load, constant AC input voltage and constant temperature)
Load regulation CR	$\leq 0.3\%$ FS + 0.1% FS current (0 - 100% load, constant AC input voltage and constant temperature)
Protective functions	
OVP	Overvoltage protection, adjustable 0 - 110% $U_{Nominal}$
OCP	Overcurrent protection, adjustable 0 - 110% $I_{Nominal}$
OPP	Overpower protection, adjustable 0 - 110% $P_{Nominal}$
OT	Overtemperature protection (DC output shuts down in case of insufficient cooling)
DC output dynamic	
Rise time 10 - 90% CV	≤ 10 ms
Fall time 90 - 10% CV	≤ 10 ms
Rise time 10 - 90% CC	≤ 2 ms
Fall time 90 - 10% CC	≤ 2 ms
Insulation	
AC input to DC output	3750 Vrms (1 minute, creepage distance >8 mm)
AC input to case (PE)	2500 Vrms
DC output to case (PE)	Depending on the model, see model tables
DC output to interfaces	1000 V DC (models up to 360 V output), 1500 V DC (models from 500 V output)
Interfaces digital	
Built-in, galvanically isolated	USB, Ethernet (100 MBit), USB front panel, all for communication
Optional, galvanically isolated	CAN, CANopen, RS232, ModBus TCP, Profinet, Profibus, EtherCAT, Ethernet
Interfaces analog	
Built-in, galvanically isolated	15 pole D-Sub
Signal range	0 - 10 V or 0 - 5 V (switchable)
Inputs	U, I, P, R, remote control on/off, DC output on/off, resistance mode on/off
Outputs	Monitor U and I, alarms, reference voltage, DC output status, CV/CC regulation mode
Accuracy U / I / P / R	0 - 10 V: $\leq 0.2\%$, 0 - 5 V: $\leq 0.4\%$
Device configuration	
Parallel operation	Up to 64 units of any power class in series 10000 start from 5 kW, with Master-Slave-Bus and Share-Bus

General specifications	
Safety and EMC	
Safety	EN 61010-1 IEC 61010-1 UL 61010-1 CSA C22.2 No 61010-1 BS EN 61010-1
EMC	EN 55011, class A CISPR 11, class A FCC 47 CFR part 15B, unintentional radiator, class A EN 61326-1 include tests according to: - EN 61000-4-2 - EN 61000-4-3 - EN 61000-4-4 - EN 61000-4-5 - EN 61000-4-6
Safety protection class	1
Ingress Protection	IP20
Environmental conditions	
Operating temperature	0 - 50 °C (32 - 122 °F)
Storage temperature	-20 - 70 °C (-4 - 158 °F)
Humidity	≤80% relative humidity, non-condensing
Altitude	≤2000 m (≤6,600 ft)
Pollution degree	2
Mechanical construction	
Cooling	Forced air flow from front to rear (temperature controlled fans), optional water cooling
Dimensions (W x H x D)	Enclosure: 19" x 4U x 668 mm (26.3 in)
Weight	50 kg (110 lb)
Weight with water cooling	56 kg (126 lb)

Technical specifications	PUB 10060-1000	PUB 10080-1000	PUB 10200-420	PUB 10360-240	PUB 10500-180
DC output					
Voltage range	0 - 60 V	0 - 80 V	0 - 200 V	0 - 360 V	0 - 500 V
Ripple in CV (rms)	≤25 mV (BW 300 kHz)	≤25 mV (BW 300 kHz)	≤40 mV (BW 300 kHz)	≤55 mV (BW 300 kHz)	≤70 mV (BW 300 kHz)
Ripple in CV (pp)	≤320 mV (BW 20 MHz)	≤320 mV (BW 20 MHz)	≤300 mV (BW 20 MHz)	≤320 mV (BW 20 MHz)	≤350 mV (BW 20 MHz)
U_{Min} for I_{Max} (sink)	0.62 V	0.62 V	1.8 V	2.5 V	1.1 V
Current range	0 - 1000 A	0 - 1000 A	0 - 420 A	0 - 240 A	0 - 180 A
Power range	0 - 30000 W	0 - 30000 W	0 - 30000 W	0 - 30000 W	0 - 30000 W
Resistance range	0.003 Ω - 5 Ω	0.003 Ω - 5 Ω	0.0165 Ω - 25 Ω	0.05 Ω - 90 Ω	0.08 Ω - 170 Ω
Output capacitance	25380 μF	25380 μF	5400 μF	1800 μF	675 μF
Efficiency sink/source (up to)	95.1% *1	95.5% *1	95.3% *1	95.8% *1	96.5% *1
Insulation					
Negative DC pole <-> PE	±600 V DC	±600 V DC	±1000 V DC	±1000 V DC	±1500 V DC
Positive DC pole <-> PE	+600 V DC	+600 V DC	+1000 V DC	+1000 V DC	+2000 V DC
Article numbers					
Standard	01123001	01123002	01123003	01123004	01123005
Standard + Water Cooling	01543001	01543002	01543003	01543004	01543005

*1 At 100% power and 100% output voltage

Technical specifications	PUB 10750-120	PUB 10920-125	PUB 11000-80	PUB 11500-60	PUB 12000-40
DC output					
Voltage range	0 - 750 V	0 - 920 V	0 - 1000 V	0 - 1500 V	0 - 2000 V
Ripple in CV (rms)	≤200 mV (BW 300 kHz)	≤250 mV (BW 300 kHz)	≤300 mV (BW 300 kHz)	≤400 mV (BW 300 kHz)	≤500 mV (BW 300 kHz)
Ripple in CV (pp)	≤800 mV (BW 20 MHz)	≤1200 mV (BW 20 MHz)	≤1600 mV (BW 20 MHz)	≤2400 mV (BW 20 MHz)	≤3000 mV (BW 20 MHz)
U_{Min} for I_{Max} (sink)	1.2 V	2 V	3.4 V	3.2 V	3.7 V
Current range	0 - 120 A	0 - 125 A	0 - 80 A	0 - 60 A	0 - 40 A
Power range	0 - 30000 W	0 - 30000 W	0 - 30000 W	0 - 30000 W	0 - 30000 W
Resistance range	0.2 Ω - 370 Ω	0.25 Ω - 550 Ω	0.4 Ω - 650 Ω	0.8 Ω - 1500 Ω	1.7 Ω - 2700 Ω
Output capacitance	450 μF	100 μF	200 μF	75 μF	50 μF
Efficiency sink/source (up to)	96.5% *1	96.5% *1	95.8% *1	96.5% *1	96.5% *1
Insulation					
Negative DC pole <-> PE	±1500 V DC	±1500 V DC	±1500 V DC	±1500 V DC	±1500 V DC
Positive DC pole <-> PE	+2000 V DC	+2000 V DC	+2000 V DC	+2000 V DC	+2000 V DC
Article numbers					
Standard	01123006	01123007	01123008	01123009	01123010
Standard + Water Cooling	01543006	01543007	01543008	01543009	01543010

*1 At 100% power and 100% output voltage

1.8.4 Views

1.8.4.1 Technical drawings PUB 10000 4U ≤ 200 V

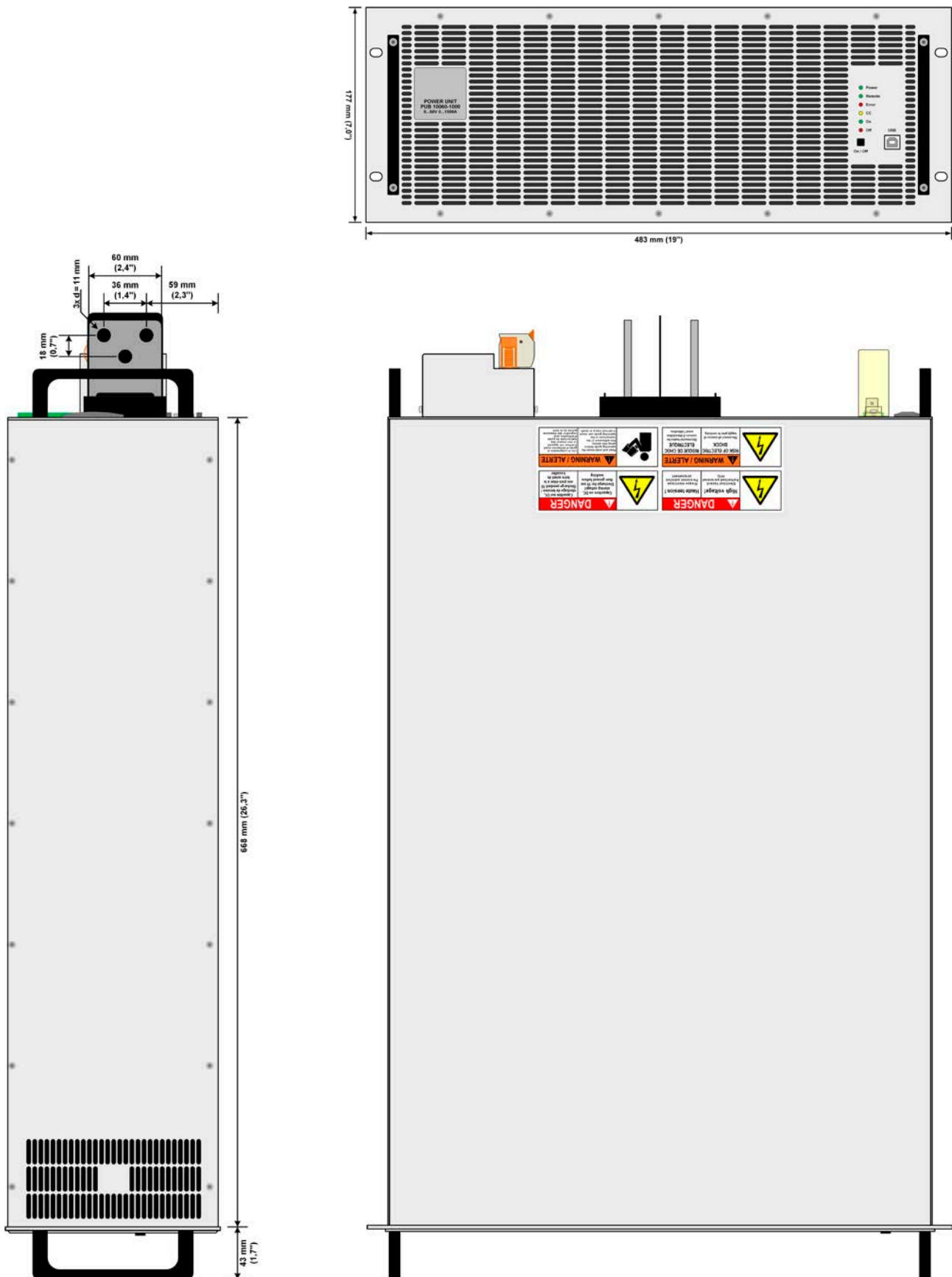

Side view of the air-cooled version shown

1.8.4.2 Front panel description PUB 10000 4U

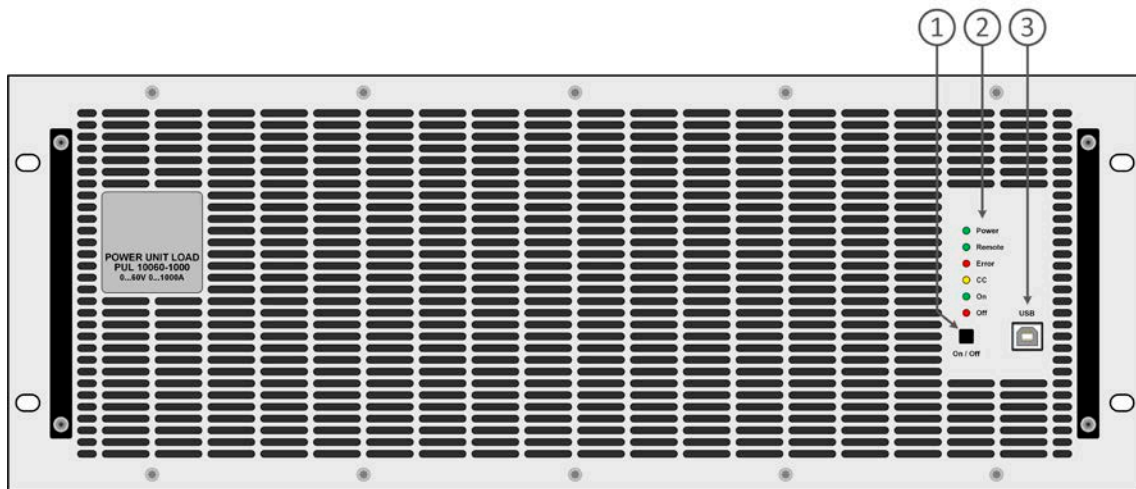

1. DC on/off pushbutton
2. LED status display
3. USB interface

1.8.4.3 Rear panel description PUB 10000 4U ≤ 200 V

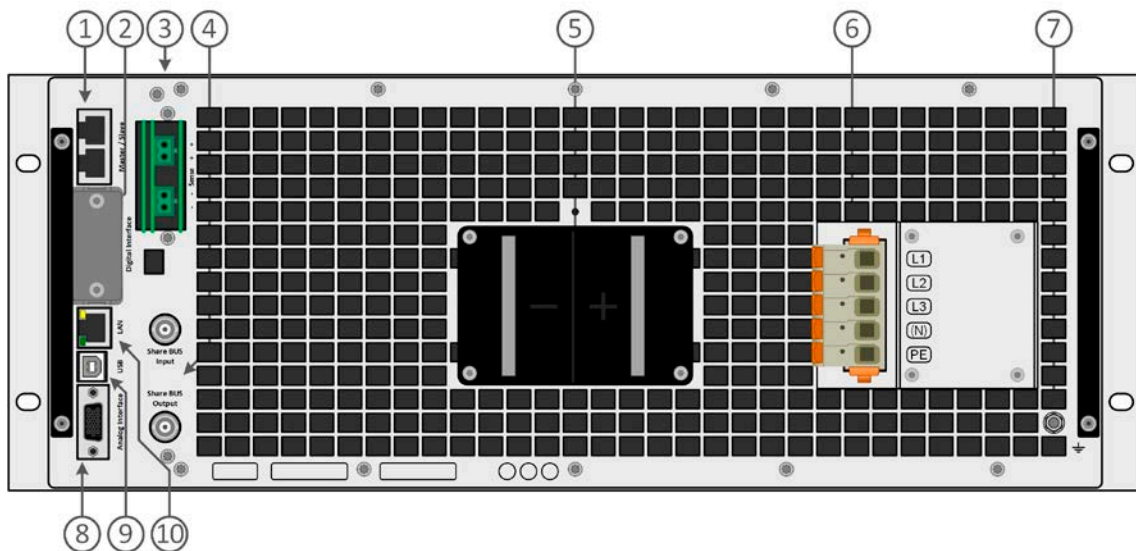

1. Master-Slave bus connectors to set up a system for parallel connection
2. Slot for interfaces
3. Remote sense connectors
4. Share bus connectors to set up a system for parallel connection
5. DC output connector (copper blades)
6. AC input connector
7. Grounding connection screw (PE)
8. Connector (DB15 female) for isolated analog programming, monitoring and other functions
9. USB interface
10. Ethernet interface

1.8.4.4 Technical drawings PUB 10000 4U ≥ 360 V

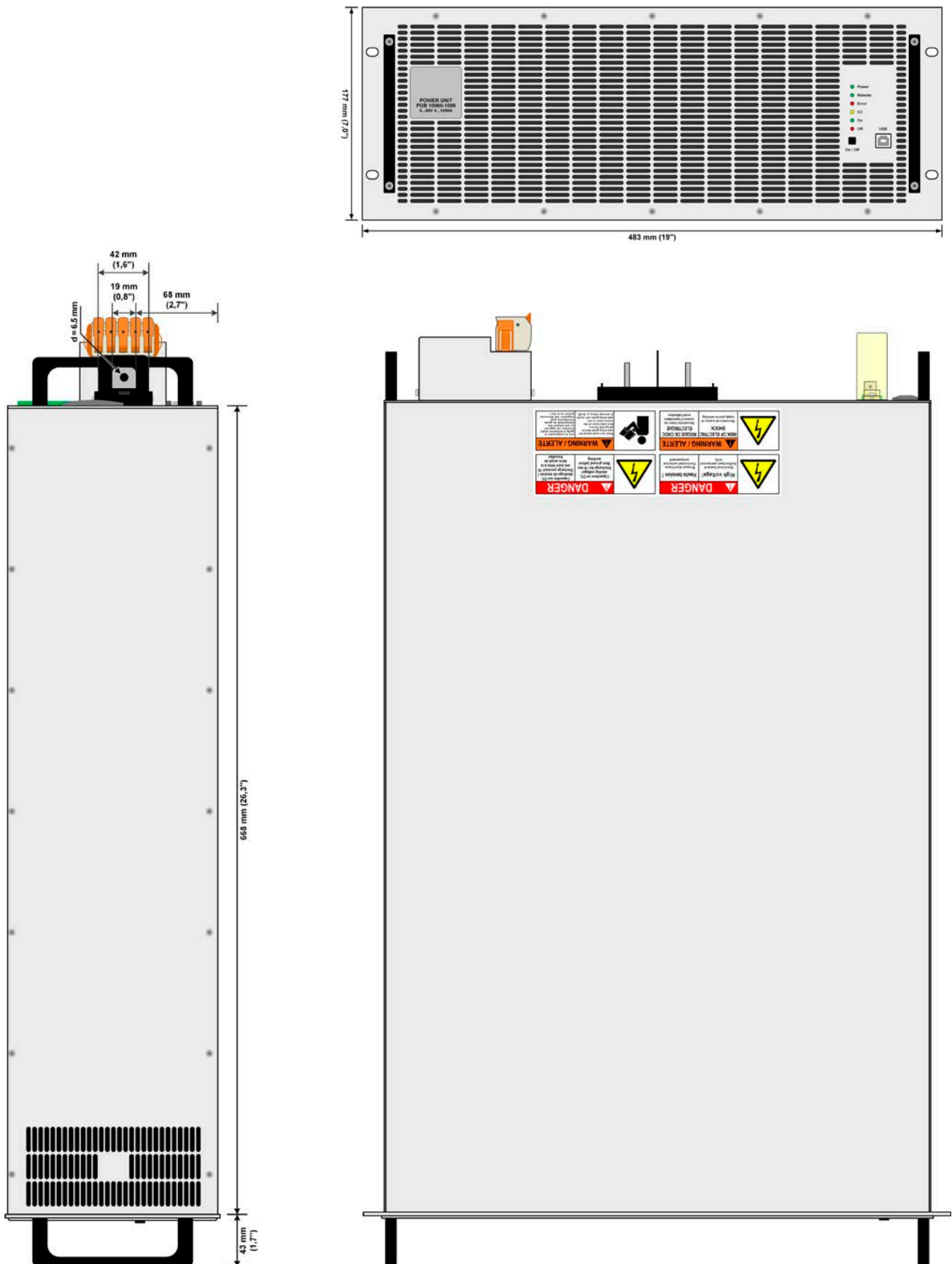

Side view of the air-cooled version shown

1.8.4.5 Front panel description PUB 10000 4U

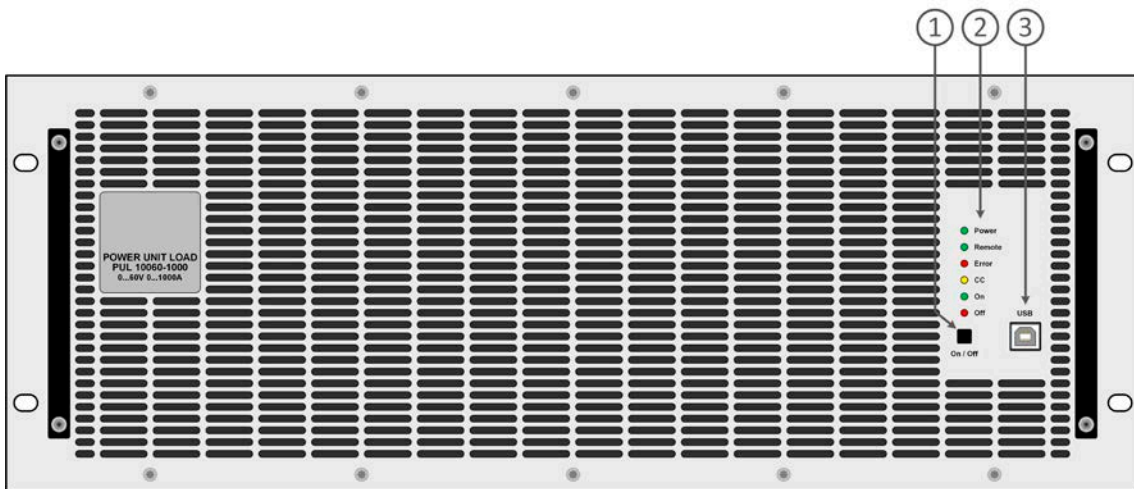

1. DC on/off pushbutton
2. LED status display
3. USB interface

1.8.4.6 Rear panel description PUB 10000 4U ≥ 360 V

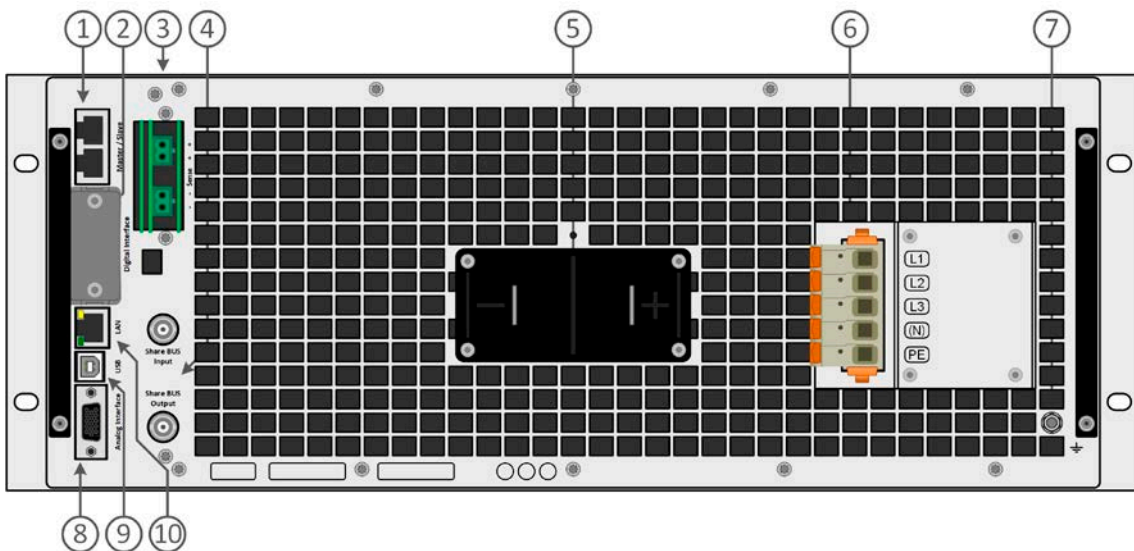

1. Master-Slave bus connectors to set up a system for parallel connection
2. Slot for interfaces
3. Remote sense connectors
4. Share bus connectors to set up a system for parallel connection
5. DC output connector (copper blades)
6. AC input connector
7. Grounding connection screw (PE)
8. Connector (DB15 female) for isolated analog programming, monitoring and other functions
9. USB interface
10. Ethernet interface

1.8.4.7 Front panel description PUB 10000 4U with Water Cooling option



1. DC on/off pushbutton
2. LED status display
3. USB interface

1.8.4.8 Rear panel description PUB 10000 4U with Water Cooling option

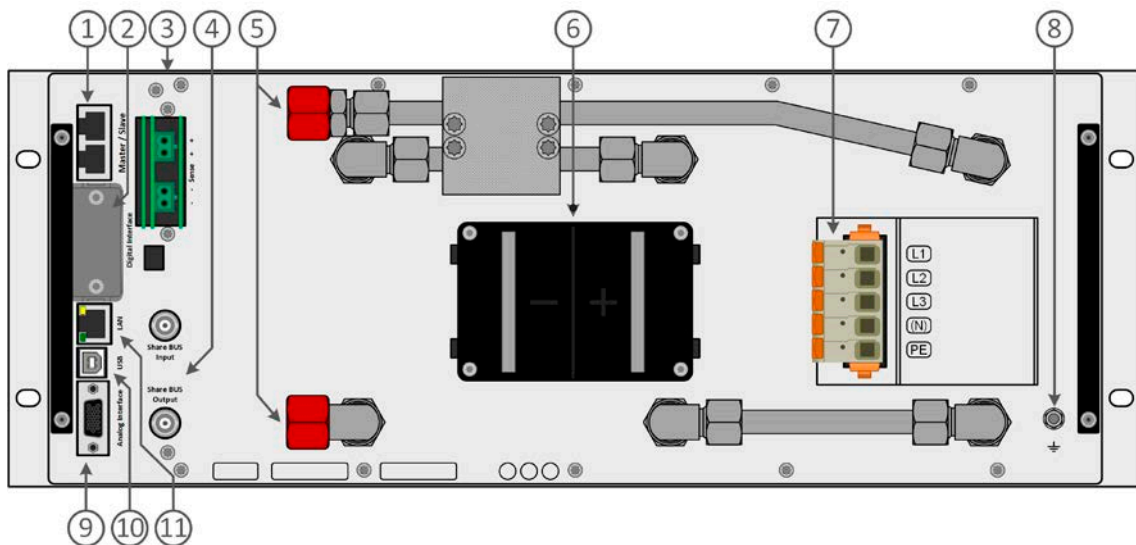

1. Master-Slave bus connectors to set up a system for parallel connection
2. Slot for interfaces
3. Remote sense connectors
4. Share bus connectors to set up a system for parallel connection
5. Inlets and outlets for water-cooling
6. DC output terminal (copper blades)
7. AC input connector
8. Grounding connection screw (PE)
9. Connector (DB15 female) for isolated analog programming, monitoring and other functions
10. USB interface
11. Ethernet interface

1.8.5 Control elements

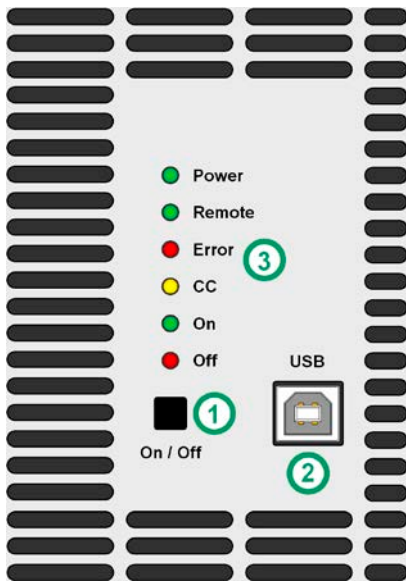



Figure 1- Control Panel

Overview of the elements on the control panel

For a detailed description see section «1.9.6 The control panel (HMI)».

(1)	<p>On/Off button</p> <p>Can be used to switch the DC output on or off during manual operation, while LED “Remote” is off</p> <div style="border: 1px solid black; padding: 5px; margin-top: 10px;">  <p><i>Pin REM-SB on the analog interface, when set to a logical level which would request to turn DC off, can block switching DC on by this pushbutton.</i></p> </div>
(2)	<p>USB port</p> <p>For quick and easy access to the most important DC output related values when the device isn't in master-slave mode. This port has reduced functionality compared to the rear port.</p>
(3)	<p>Status indicators (LED)</p> <p>These six color LEDs show the device status.</p>

1.9 Construction and function

1.9.1 General description

The devices in series PUB 10000 4U represent matching models to series PSB 10000 4U and PSBE 10000 4U. They serve as extension modules, so called power units, which are intended to build master-slave systems with higher total power. Devices from series PSB 10000 4U or PSBE 10000 4U, which both have a color touch display, can serve as master unit, but all PUB 10000 4U can also serve as master for other 10000 series power supplies should the control be solely remote.

For remote control the devices are provided as standard with USB and Ethernet ports on the rear side, as well as a galvanically isolated analog interface. Via optional plug-in interface modules, another digital interface such as for RS232, Profibus, ProfiNet, ModBus TCP, CAN, CANopen or EtherCAT can be added. These enable the devices to be connected to standard industrial buses simply by changing or adding a small module.

Alternatively to the air-cooled versions there are also water-cooled version available which are usually configured and offered in cabinet systems with a complete water cooling distribution inside. For DIY water-cooled systems single units can also be obtained upon request.

1.9.2 Block diagram

The block diagram illustrates the main components inside the device and their relationships.

There are digital, microprocessor controlled components (KE, DR, HMI), which can be target of firmware updates.

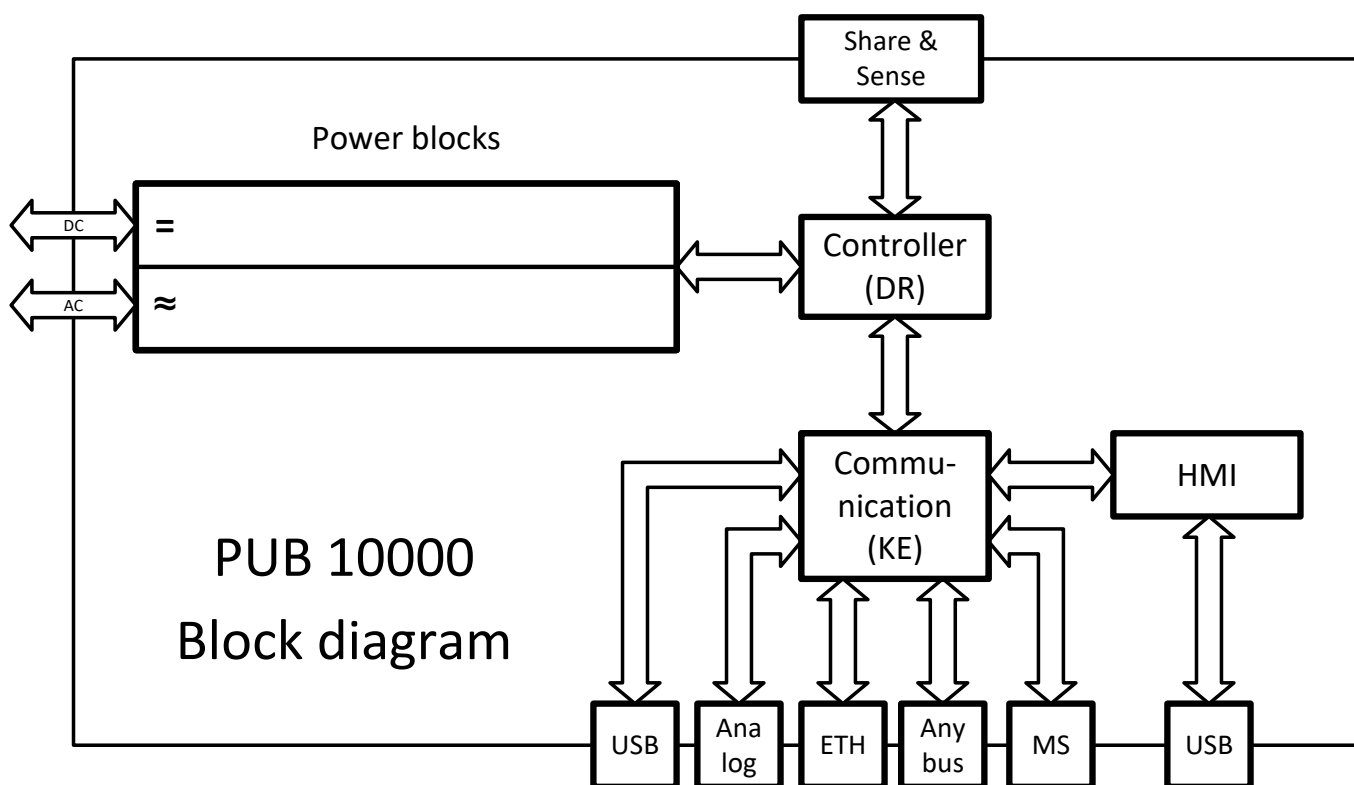

1.9.3 Scope of delivery

- 1 x Bidirectional power supply device
- 2 x Remote sensing plugs
- 1 x 1.8 m (5.9 ft) USB cable
- 1 x Set of DC terminal covers
- 1 x Sense terminal cover
- 1 x USB stick with documentation and software
- 1 x AC connector plug (clamp type)
- 1 x Set for AC cable strain relief

1.9.4 Accessories

For all models in this series, with or without water cooling option installed, the following accessories are available:

IF-AB Interface modules	Pluggable and retrofittable, digital interface modules for RS232, CANopen, Profibus, ProfiNet, ModBus TCP, EtherCAT or CAN are available. Details about the interface modules and the programming of the device using those interfaces can be found in separate documentation. It's usually available on the USB stick, which is included with the device, or as PDF download on the manufacturers website.
EABS Battery simulation	EABS is short for EA Battery Simulator and is an optionally available, USB dongle licensed Windows software. In combination with the bidirectional power supplies of series PSB 9000, PSBE 9000, PSB 10000 and PSBE 10000 it simulates either a single lithium-ion cell or lead-acid battery or multiple in series and/or parallel connection. The simulation works with battery typical values such as capacity, temperature, state of charge, internal resistance and cell voltage, plus adjustable test conditions.

1.9.5 Options

These options are usually ordered along with the device, as they are permanently built in or preconfigured during the manufacturing process.

POWER RACKS 19" rack	Racks in various configurations up to 42U as parallel systems are available, or mixed with electronic load devices to create test systems. Further information in our product catalogue, on our website or upon request
WC Water cooling	Replaces the standard cooling blocks of the internal power stages by three interconnected, water cooled blocks with two taps led out for supply. This options helps to avoid heating up the environment due to exhausted heat caused by a certain power dissipation when the device or a cabinet full of units runs as source. As a side effect, this type of cooling also reduces audible noise.

1.9.6 The control panel (HMI)

The HMI (Human Machine Interface) consists of six colored LEDs, a pushbutton and a USB port of type B.

1.9.6.1 Status indicators (LED)

The six colored LEDs on the front indicate various statuses of the device:

LED	Color	Indicates what when lit?
Power	orange / green	Orange = device is in boot phase or internal error occurred Green = device is ready for operation
Remote	green	Remote control by master-slave or any of the control interfaces is active. In this situation, manual control with button On/Off is locked.
Error	red	At least one unacknowledged device alarm is active. The LED signalizes all alarms as listed in «3.7 Alarms and monitoring».
CC	yellow	Constant current regulation (CC) is active. It means, if the LED isn't lit it indicates either CV, CP or CR mode. Also see «3.3 Operating modes».
On	green	DC output is switched on
Off	red	DC output is switched off

1.9.6.2 Front USB port

The front USB port is easier to access than the one on the rear side and intended for quick setup of DC output related values and settings. Doing so is only necessary and possible in these two situations:

1. The PUB 10000 4U isn't currently controlled by a master.
2. The PUB 10000 4U shall, due to the lack of a suitable PSB 10000 4U or PSBE 10000 4U master device, be the master of other PUB 10000 4U devices.

Both situations are only secondary, as the primary and normal function of a PU 10000 4U is to be a slave in a master-slave system where it's assigned all required settings and values from the master.

When running any of the above listed situations following applies for the front USB port:



- Reduced instruction set for master-slave configuration, set values (U, I, P, R) and protections (OVP, OCP, OPP). For details about the instruction set see «3.6 Remote control».
- Taking over remote control in order to change the configuration is only possible while the unit isn't online with the master, which either requires to temporarily deactivate master-slave on the master or to switch the master off.

1.9.6.3 Pushbutton "On / Off"

This button can be used to switch the DC output on or off during manual control, i. e. the device isn't in remote control by a master or via any of the USB ports (LED "Remote" = off), but only if the DC output isn't blocked by pin REM-SB (analog interface).



Once pushed to switch the DC output on, the device would regulate it to the last values it has stored. Since all the DC output related values aren't displayed, operating that button has to be done with caution.

The button can furthermore be used to quickly and without the need of a PC turn the device into slave mode. This is done by pressing and holding the button for at least 10 seconds. The switchover into mode "Slave" is confirmed by the LED "Error" lighting up, indicated an MSP alarm (see section «3.7 Alarms and monitoring» for more information about this alarm) which is normal for not yet initialized slave.

1.9.7 USB port (rear side)

The USB port on the rear side of the device is provided for communication with the device and for firmware updates. The included USB cable can be used to connect the device to a PC (USB 2.0 or 3.0). The driver is delivered with the device and installs a virtual COM port. Details about remote control can be found in form of a programming guide on the included USB stick or on the web site of the manufacturer.

The device can be addressed via this port either using the international standard ModBus RTU protocol or by SCPI language. The device recognizes the message protocol used automatically.

If remote control is in operation the USB port has no priority over either the interface module (see below) or the analog interface and can, therefore, only be used alternatively to these. However, monitoring is always available.

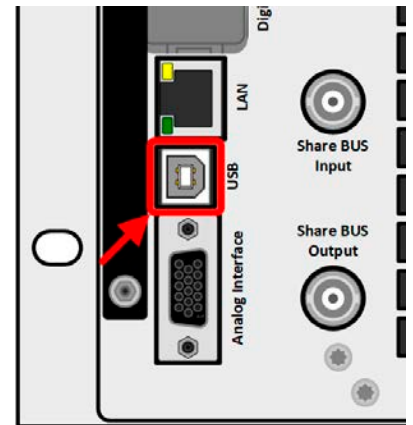

Figure 2 - USB port

1.9.8 Interface module slot

This slot on the rear side of the device is can receive various modules of the IF-AB interface series. The following options are available:

Article number	Name	Description
35400100	IF-AB-CANO	CANopen, 1x DB9, male
35400101	IF-AB-RS232	RS 232, 1x DB9, male (null modem)
35400103	IF-AB-PBUS	Profibus DP-V1 Slave, 1x DB9, female
35400104	IF-AB-ETH1P	Ethernet, 1x RJ45
35400105	IF-AB-PNET1P	ProfiNET IO, 1x RJ45
35400107	IF-AB-MBUS1P	ModBus TCP, 1x RJ45
35400108	IF-AB-ETH2P	Ethernet, 2x RJ45
35400109	IF-AB-MBUS2P	ModBus TCP, 2x RJ45
35400110	IF-AB-PNET2P	ProfiNET IO, 2x RJ45
35400111	IF-AB-CAN	CAN 2.0 A / 2.0 B, 1x DB9, male
35400112	IF-AB-ECT	EtherCAT, 1x RJ45

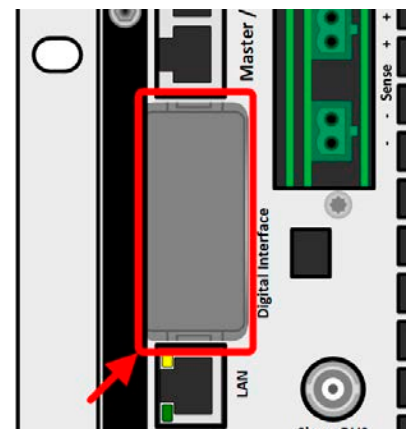

Figure 3 - Interface slot

The modules can be installed by the user and hence retrofitted without problem. A firmware update of the device may be necessary in order to recognize and support certain modules.



Switch your device off before adding or removing modules!

1.9.9 Analog interface

This 15 pole D-sub socket on the rear side of the device is provided for remote control of the device via analog or digital signals.

If remote control is in operation this analog interface can only be used alternately to the digital interface. However, monitoring is always available.

The input voltage range of the set values and the output voltage range of the monitor values, as well as reference voltage level can be switched with a setting between 0-5 V and 0-10 V, in each case corresponding to 0-100%.

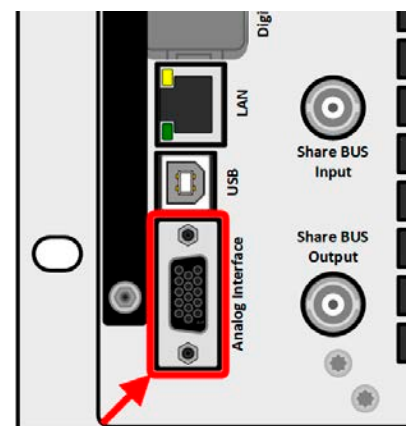

Figure 4 - Analog interface

1.9.10 “Share BUS” connector

The two BNC sockets (50 Ω type) labeled “Share BUS” form a digital, passed-through Share bus. This bus is bidirectional and connects the bus master unit via “Share BUS Output” to the next slave unit (“Share BUS Input”) etc., for use in parallel operation (master-slave). BNC cables of suitable length can be obtained from us or electronics stores.

Basically, all 10000 series are compatible on this Share bus, though only connection of the same device type, i. e. power supply with power supply or electronic load with electronic load is supported by the devices for master-slave.

For a PUB 10000 series device, identical PUB 10000 series models can be used as slave units. A PUB 10000 device can furthermore be the slave or master of PSB 10000 or PSBE 10000 series devices.

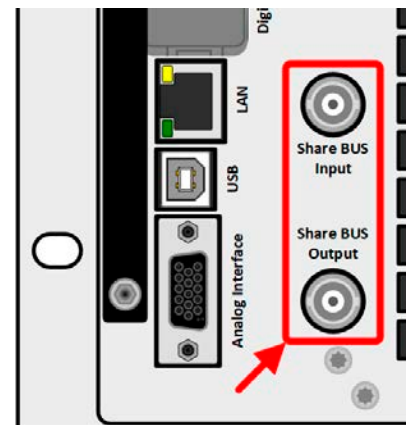

Figure 5 - Share bus

1.9.11 “Sense” connector (remote sensing)

In order to compensate for voltage drops along the DC cables to the load or external source, the Sense input (2 plugs included in delivery, one each for positive and negative pole) can be connected to the load resp. external source. The maximum possible compensation is given in the technical specifications.



In a master-slave system it's intended to wire remote sensing only to the master which would then forward the compensation to the slaves via Share bus.



The Sense cover must be installed during operation, because there can be hazardous voltage on the sense lines! Reconfiguration on the Sense connectors is only permissible if the device is disconnected from AC supply and all DC sources!

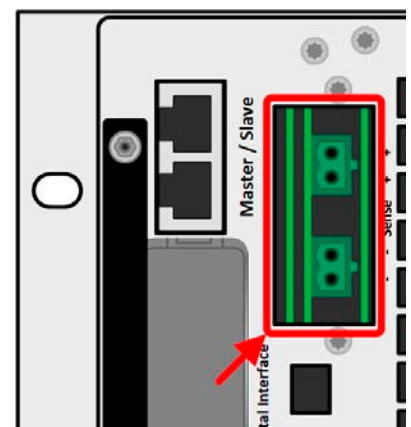

Figure 6 - Remote sensing connectors

1.9.12 Master-Slave bus

There is a further set of connectors on the rear side of the device, comprising two RJ45 sockets, which enables multiple compatible devices to be connected via a digital bus (RS485) in order to create a master-slave system. Connection is made using standard CAT5 cables.

It's recommended to keep the connections as short as possible and to terminate the bus if required. The termination is done via digital switches that can be activated by remote control via SCPI or ModBus command, as well as in the Settings app of **EA Power Control**.

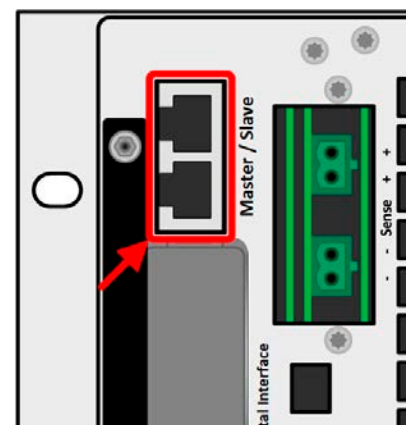

Figure 7 - Master slave bus ports

1.9.13 Ethernet port

The RJ45 LAN/Ethernet port on the rear side of the device is provided for communication with the device in terms of remote control or monitoring. The user has basically two options of access:

1. A website (HTTP, port 80) which is accessible in a standard browser via the IP or the host name given for the device. This website offers a configuration page for network parameters, as well as an input box for SCPI commands to control the device remotely by manually entering commands.
2. TCP/IP access via a freely selectable port (except 80 and other reserved ports). The standard port for this device is 5025. Via TCP/IP and the selected port, communication to the device can be established in most of the common programming languages. Using this LAN port, the device can either be controlled by commands from SCPI or ModBus RTU protocol, while automatically detecting the type of message.

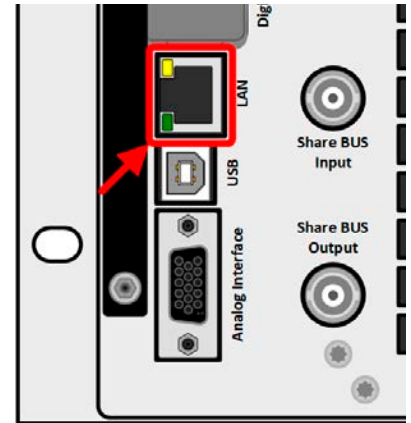

Figure 8- LAN port

Access via ModBus TCP protocol is only supported by the optionally and separately available ModBus TCP interface module. See «1.9.8 Interface module slot».

The network setup can be done manually or by DHCP. Transmission speed and duplex mode are on automatic mode.

If remote control is in operation the Ethernet port has no priority over any other interface and can, therefore, only be used alternatively to these. However, monitoring is always available.

1.9.14 Water cooling

Models with water cooling are optionally available as replacement of the default models with air-cooling. This option is built in during the manufacturing process, so retrofitting isn't possible. Cooling the device with water instead of air comes with a few advantages:

- Less ambient noise generated by the device
- Better cooling at higher ambient temperatures
- No direct dissipation of heat into the ambiance of the device

However, there also disadvantages:

- The device isn't allowed to run under load without active water flow
- Water flow inside an electronic device includes a higher risk of damage caused by a leak or by condensation of water from air humidity (bedewing)

The water taps are located on the rear side of the device, also see the rear view drawing in section 1.8.4. Details about the connection, requirements and use of the water cooling can be found in section 2.3.4.

2. Installation & commissioning

2.1 Transport and storage

2.1.1 Transport



- The handles on the front and rear side of the device are **not** for carrying!
- Because of its weight, transport by hand should be avoided where possible. If unavoidable then only the housing should be held and not on the exterior parts (handles, DC terminal, rotary knobs).
- Do not transport when switched on or connected!
- When relocating the equipment use of the original packing is recommended
- The device should always be carried and mounted horizontally
- Use suitable safety clothing, especially safety shoes, when carrying the equipment, as due to its weight a fall can have serious consequences.

2.1.2 Packaging

It's recommended to keep the complete transport packaging for the lifetime of the device for relocation or return to the manufacturer for repair. Otherwise the packaging should be disposed of in an environmentally friendly way.

2.1.3 Storage

In case of long term storage of the equipment it's recommended to use the original packaging or similar. Storage must be in dry rooms, if possible in sealed packaging, to avoid corrosion, especially internal, through humidity.

2.2 Unpacking and visual check

After every transport, with or without packaging, or before commissioning, the equipment should be visually inspected for damage and completeness using the delivery note and/or parts list (see section «1.9.3 Scope of delivery»). An obviously damaged device (e.g. loose parts inside, damage outside) must under no circumstances be put in operation.

2.3 Installation

2.3.1 Safety procedures before installation and use



- The device has a considerable weight. Therefore the proposed location of the equipment (table, cabinet, shelf, 19" rack) must be able to support the weight without restriction.
- When using a 19" rack, rails suitable for the width of the housing and the weight of the device are to be used (see «1.8 Technical Data»)
- Before connecting to the mains ensure the supply voltage is as shown on the product label. Overvoltage on the AC supply can cause equipment damage.
- Devices of this series feature an energy recovery function which, similar to solar energy equipment, feeds energy back into the local or public grid. Feedback into the public grid must not be operated without adherence of directives from the local energy supplying company and it must be investigated before the installation or latest before initial commission if there is requirement to install a grid protection device!

2.3.2 Preparation

2.3.2.1 Planning a master-slave system

Due to the primary use of PUB 10000 series devices being a slave in a master-slave system, before any further planning of installation and wiring it's recommend to decide how the master-slave system shall be configured. The smallest setup would consist of 1x PSB 10000 or PSBE 10000 and 1x PUB 10000, when using a master with display, or 2x PUB 10000.

Both, master and slave unit, must be of same rating regarding voltage and ideally also current and power. There are several possible combinations of standard models and the power units:

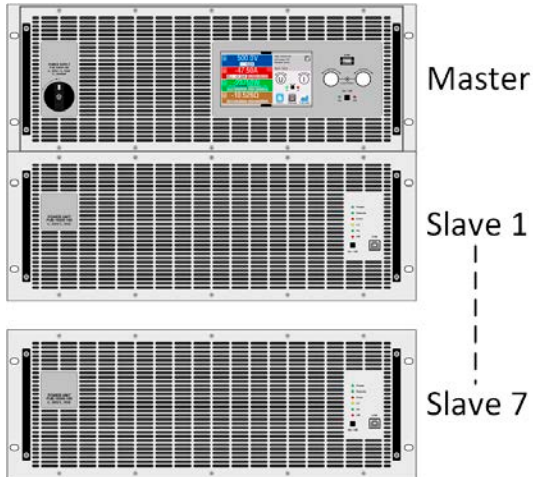

Combination 1:

One master with one or multiple PUB 10000 as slaves

This is the intended combination for models of PUB 10000 series, as it allows to have a master which sums up all values on its display and which, if from series PSB 10000, can have a function generator while the slave unit(s) don't need to have one.

Advantage of this combination: lower costs compared to a system where all units are with display

Disadvantages of this combination: in case the master fails, the entire system can't either work or at least not use the function generator anymore. After reconfiguring any slave unit to be the master, which can be done via software and remote control, the system can continue to operate with reduced features, but without a values display. However, it can of course be controlled remotely via software.

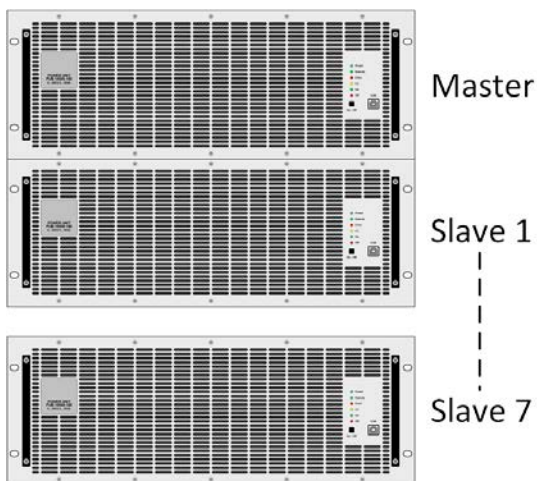

Combination 2:

Multiple PUB 10000

An already existing MS system with PUB 10000 is going to be extended by one or multiple PUB 10000 units or a new system is built. One of the usually identical devices is picked to be the master unit and configured accordingly. This combination has the highest potential of cost saving and is ideal when being part of a bigger system where it's intended to be used via remote control only.

Advantage of this combination: in case of a failing master, any other PUB 10000 unit can be quickly reconfigured to be master.

Disadvantages of this combination: if the system only consist of models of PUB 10000 series, the available features are limited to what is defined for a single device.

2.3.2.2 Selecting cables

The required AC supply connection for these device is termination. It's done via the 5 pole AC connector on the rear (AC filter box). A matching plug is included. Wiring of the plug is at least 4 wire (3x L, PE) of suitable cross section and length. Full configuration with all phases plus N and PE is permissible.

For recommendations for a cable cross section see «2.3.5 Connection to AC supply». Dimensioning of the DC wiring to the load/consumer has to reflect the following:



- The cable cross section should always be specified for at least the maximum current of the device.
- Continuous operation at the approved limit generates heat which must be removed, as well as voltage loss which depends on cable length and heating. To compensate for these the cable cross section should be increased and the cable length reduced.

2.3.2.3 Additional measure for energy recovering devices

All models of this series are so-called recuperating devices, at least when they're working in sink mode. In this mode they feed back a specific amount of energy into the local or public grid. The devices can't work sink mode without this functionality. The goal is to consume the recovered energy completely in the local power grid of a company or plant. In case it can occur that more energy is recuperated than consumed, the excess will be fed back into the public grid which usually isn't allowed without further precautions.

The operator of the device must, owing to circumstances, contact the local electric utility and clarify what's allowed and if a so-called network & system protection is required to be installed. There are several different international provisions or standard, such as the german VDE-AR-N 4105/4110 or the british ENA EREC G99 which regulate this situation.

The device itself provides a basic protection and would shut down energy feed back in case it can't work, but a full protection against frequency shift or voltage deviation can only be accomplished by such an NS protection device, which will also prevent isolation operation.

We offer NS protection solutions. They already fulfill the german AR-N 4105 and 4410, as well as the italian CEI 0-21 or the british G59/G98/G99.

Concept of an NS protection system:

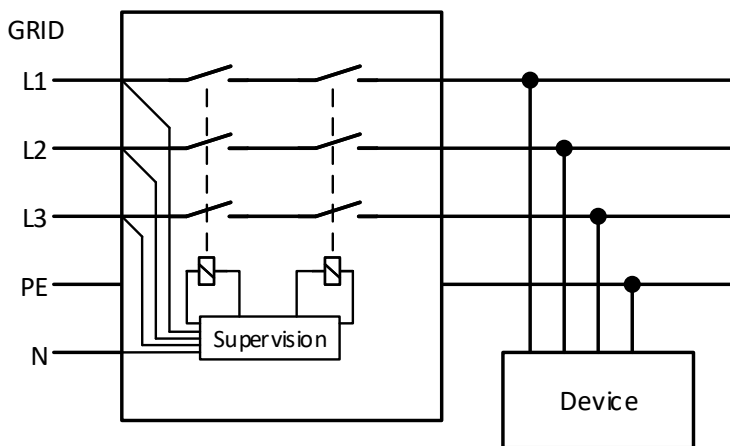
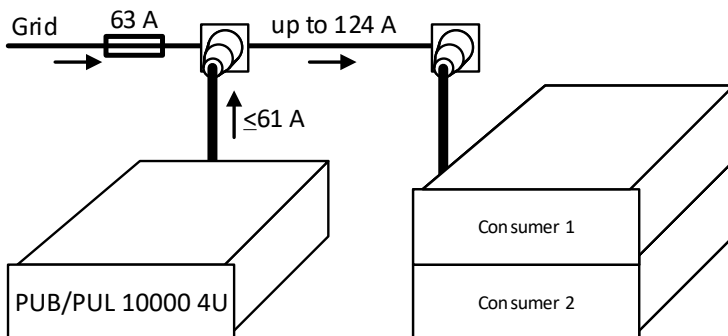

Figure 9 - Principle of an NS protection network

2.3.2.4 Installation concept for energy recovering devices

When working as electronic load (sink mode), a PUB 10000 device recovers energy and feeds it back into the local power grid at the point of installation or a big electric network (power grid). The recovered current adds to the grid current (see schematic below) and this can lead to an overload of the existing electric installation. Considering any two outlets, no matter of what type they are, there is usually no extra fusing installed in between. In case of a defect in the AC part (i.e. short-circuit) of any consumer device or when there are multiple devices connected which could take a higher power, the total current could flow across wires which are not laid out for this higher current. It could lead to damage or even fire in the wires or connection points.

In order to avoid damages and accidents, the existing installation concept must be taken into regard before installing such recovering devices. Schematic depiction with 1 recovering device and consumers:



When running a higher number of recovering, i. e. energy backfeeding units on the same leg of the installation, the total currents per phase increases accordingly.

2.3.3 Installing the device



- Select the location for the device so that the connection to the load resp. source is as short as possible.
- Leave sufficient space, at least 30 cm (1 ft), behind the equipment for ventilation (only required for the standard air-cooled version)
- The device must not be operated without a proper touch protection on the AC connector, which is either only accomplished by installation of the device in a 19" rack/cabinet with lockable doors or by applying further measures (additional cover etc.)

All models in this series require to be installed and operated in a closed appliance, such as a cabinet. It's also mandatory to install a rigid AC connection. Open operation on a desk or similar isn't permissible.

A device in a 19" chassis will usually be mounted on suitable rails and installed in 19" racks or cabinets. The depth of the device and its weight must be taken into account. The handles on the front are for sliding in and out of the cabinet. Slots on the front plate are provided for fixing the device (fixing screws not included).

The unacceptable positions, as shown below, are also valid for the vertical mount of the device onto a wall (room or inside a cabinet). The required air flow would be insufficient.

Acceptable and unacceptable installation positions (air or water cooled, air cooled shown):

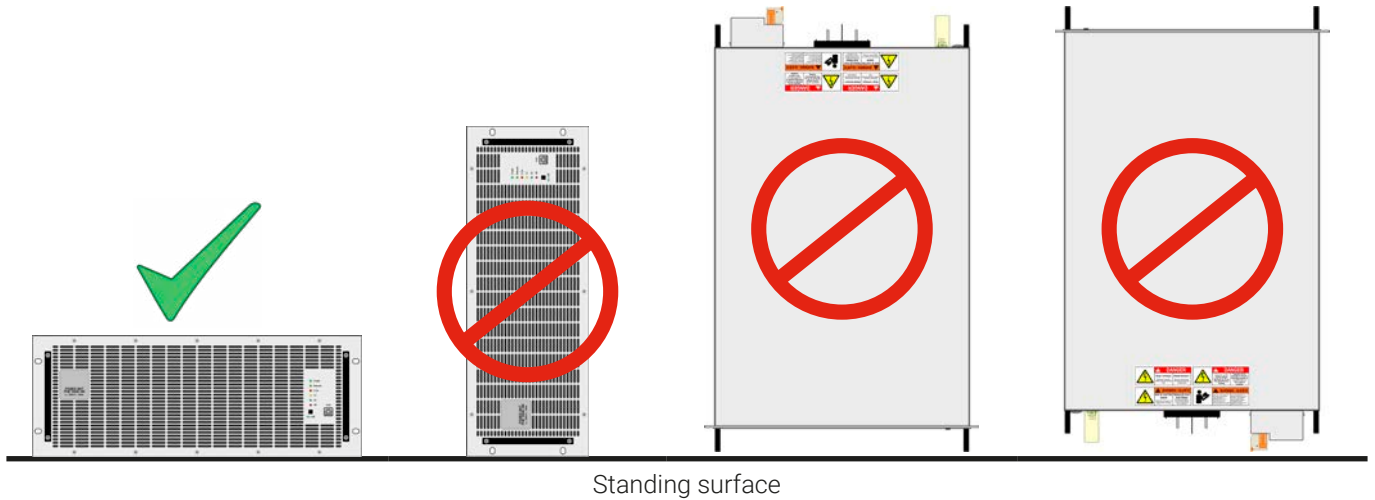

2.3.4 Connection to water supply (WC models)

If already available, the water supply should be connected and any further measures related to water cooling installation should be carried out before the AC supply for the device is connected, let alone the unit is powered. Correct installation and connection, test for **watertightness** and later operation lie in the sole responsibility of the operator or end user.

2.3.4.1 Requirements

The water pipe construction is identical with all models in this series but due to the rated current and hence different heat dissipation per minute in the internal cooling block, a model depending requirement to the water and the ambience must be met:

Model	10 V / 60 V / 80 V	200 V to 2000 V
Internal water flow:	Series	Series
Ambient temperature:	Max. +50 °C (122 °F)	Max. +50 °C (122 °F)
Water intake temperature (min):	See dew point tables below	See dew point tables below
Water intake temperature (max):	+33 °C (82 °F)	+26 °C (91 °F)
Flow rate:	Min. 12 l/minute (3.17 gal/minute)	Min. 7 l/minute (1.85 gal/minute)
Corrosion protection:	Ethylene glycol	Ethylene glycol
Water hardness:	Soft (calcium carbonate < 2 mmol/l)	Soft (calcium carbonate < 2 mmol/l)
Water pressure:	Min. 1 bar (14 psi), max. 4 bar (58 psi)	Min. 1 bar (14 psi), max. 4 bar (58 psi)

2.3.4.2 Connection point

The device has three separate cooling blocks internally, each with its own water pipe. All pipes are led out and connected outside of the device. The water will thus flow through all three pipes in parallel. On the rear of the device are two taps (tee pieces) for water connection:

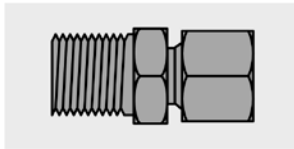

Tap: angle piece
Thread: M16x1.5

Which one of the two taps is used for intake and outlet is arbitrary. For later use it's only important to have a sufficient amount of water flowing through the pipes, along with a certain water intake temperature.

The hose connection is either directly done on the tee or end piece, using the metric thread, or by using a hose tail swivel, for example one from company Schwer Fittings, type SA-DKL90. This swivel is already sealing upon mount, using a 24° metal cone.

2.3.4.3 Operation and supervision

Once the water cooling is installed and running, there is one primary value left to supervise permanently, the so-called dew point. Depending on the temperature of water on the intake in combination with the humidity of ambient air and also the air inside the device water can condensate, i. e. dew inside the device. This must be avoided under all circumstances! It means, it might be required to have regulated water cooling system in order to react to varying ambient conditions.

The dew point is defined in several norms, for instance DIN 4108. The table below defines the dew point (air humidity to water) **in °C in the upper table** and **in °F in the lower table** at specific ambient temperatures and air humidity levels. The intake water temperature must always be higher than the dew point:

Ambient	Relative air humidity in per cent										
	45%	50%	55%	60%	65%	70%	75%	80%	85%	90%	95%
14°C	2.2	3.76	5.1	6.4	7.58	8.67	9.7	10.71	11.64	12.55	13.36
15°C	3.12	4.65	6.07	7.36	8.52	9.63	10.7	11.69	12.62	13.52	14.42
16°C	4.07	5.59	6.98	8.29	9.47	10.61	11.68	12.66	13.63	14.58	15.54
17°C	5	6.48	7.92	9.18	10.39	11.48	12.54	13.57	14.5	15.36	16.19
18°C	5.9	7.43	8.83	10.12	11.33	12.44	13.48	14.56	15.41	16.31	17.25
19°C	6.8	8.33	9.75	11.09	12.26	13.37	14.49	15.47	16.4	17.37	18.22
20°C	7.73	9.3	10.72	12	13.22	14.4	15.48	16.46	17.44	18.36	19.18
21°C	8.6	10.22	11.59	12.92	14.21	15.36	16.4	17.44	18.41	19.27	20.19
22°C	9.54	11.16	12.52	13.89	15.19	16.27	17.41	18.42	19.39	20.28	21.22
23°C	10.44	12.02	13.47	14.87	16.04	17.29	18.37	19.37	20.37	21.34	22.23
24°C	11.34	12.93	14.44	15.73	17.06	18.21	19.22	20.33	21.37	22.32	23.18
25°C	12.2	13.83	15.37	16.69	17.99	19.11	20.24	21.35	22.27	23.3	24.22
26°C	13.15	14.84	16.26	17.67	18.9	20.09	21.29	22.32	23.32	24.31	25.16
27°C	14.08	15.68	17.24	18.57	19.83	21.11	22.23	23.31	24.32	25.22	26.1

Ambient	Relative air humidity in per cent										
	45%	50%	55%	60%	65%	70%	75%	80%	85%	90%	95%
28°C	14.96	16.61	18.14	19.38	20.86	22.07	23.18	24.28	25.25	26.2	27.18
29°C	15.85	17.58	19.04	20.48	21.83	22.97	24.2	25.23	26.21	27.26	28.18
30°C	16.79	18.44	19.96	21.44	23.71	23.94	25.11	26.1	27.21	28.19	29.09
32°C	18.62	20.28	21.9	23.26	24.65	25.79	27.08	28.24	29.23	30.16	31.17
34°C	20.42	22.19	23.77	25.19	26.54	27.85	28.94	30.09	31.19	32.13	33.11
36°C	22.23	24.08	25.5	27	28.41	29.65	30.88	31.97	33.05	34.23	35.06
38°C	23.97	25.74	27.44	28.87	30.31	31.62	32.78	33.96	35.01	36.05	37.03
40°C	25.79	27.66	29.22	30.81	32.16	33.48	34.69	35.86	36.98	38.05	39.11
45°C	30.29	32.17	33.86	35.38	36.85	38.24	39.54	40.74	41.87	42.97	44.03
50°C	34.76	36.63	38.46	40.09	41.58	42.99	44.33	45.55	46.75	47.9	48.98

Ambient	Relative air humidity in per cent										
	45%	50%	55%	60%	65%	70%	75%	80%	85%	90%	95%
58°F	36	38.8	41.2	43.6	45.7	47.7	49.5	51.3	53	54.6	56.1
59°F	37.7	40.4	43	45.3	47.4	49.4	51.3	53.1	54.8	56.4	58
61°F	39.4	42.1	44.6	47	49.1	51.1	53.1	54.8	56.6	58.3	60
63°F	41	43.7	46.3	48.6	50.8	52.7	54.6	56.5	58.1	59.7	61.2
65°F	42.7	45.4	47.9	50.3	52.4	54.4	56.3	58.3	59.8	61.4	63.1
67°F	44.3	47	49.6	52	54.1	56.1	58.1	59.9	61.6	63.3	64.8
68°F	46	48.8	51.3	53.6	55.8	58	59.9	61.7	63.4	65.1	66.6
70°F	47.5	50.4	52.9	55.3	57.6	59.7	61.6	63.4	65.2	66.7	68.4
72°F	49.2	52.1	54.6	57.1	59.4	61.3	63.4	65.2	67	68.6	70.2
74°F	50.8	53.7	56.3	58.8	60.9	63.2	65.1	66.9	68.7	70.5	72.1
76°F	52.5	55.3	58	60.4	62.8	64.8	66.6	68.6	70.5	72.2	73.8
77°F	54	56.9	59.7	62.1	64.4	66.4	68.5	70.5	72.1	74	75.6
79°F	55.7	58.8	61.3	63.9	66.1	68.2	70.4	72.2	74	75.8	77.3
81°F	57.4	60.3	63.1	65.5	67.7	70	72.1	74	75.8	77.4	79
83°F	59	61.9	64.7	66.9	69.6	71.8	73.8	75.8	77.5	79.2	81
85°F	60.6	63.7	66.3	68.9	71.3	73.4	75.6	77.5	79.2	81.1	82.8
86°F	62.3	65.2	68	70.6	74.7	75.1	77.2	79	81	82.8	84.4
90°F	65.6	68.6	71.5	73.9	76.4	78.5	80.8	82.9	84.7	86.3	88.2
94°F	68.8	72	74.8	77.4	79.8	82.2	84.1	86.2	88.2	89.9	91.6
97°F	72.1	75.4	77.9	80.6	83.2	85.4	87.6	89.6	91.5	93.7	95.2
101°F	75.2	78.4	81.4	84	86.6	89	91.1	93.2	95.1	96.9	98.7
104°F	78.5	81.8	84.6	87.5	89.9	92.3	94.5	96.6	98.6	100.5	102.4
113°F	86.6	90	93	95.7	98.4	100.9	103.2	105.4	107.4	109.4	111.3
122°F	94.6	98	101.3	104.2	106.9	109.4	111.8	114	116.2	118.3	120.2

2.3.4.4 Notes

- The water flow should be started prior to powering the device, but at least prior to switching the DC terminal on

2.3.5 Connection to AC supply



- Connection to an AC supply must only be carried out by qualified personnel and the device must always be run directly on a power grid (transformer are permitted) and not on generators or UPS equipment!
- Cable cross section must be suitable for the maximum input current of the device! See tables below.
- According to standard EN 61010, the device must be fused externally and the fuse rating must be appropriate to the maximum AC current rating and AC cable cross section
- Ensure that all regulations for the operation of the device and connection to the public grid of energy recovering equipment have been considered and requirements have been met!
- WC models: For safety reasons it's recommended to install a 30 mA RCD for every water-cooled unit (option WC) or at least one per three units (due to the possible leak current, see technical data), in case multiple WC models run in parallel
- The devices don't feature a power switch, so they definitely require to be powered by external means, such as a contactor or a main switch or directly at the required external 3-phase circuit breaker
- In a cabinet system with 2-8 units per cabinet and when powering all units in the cabinet at once by the external switching installation, very high inrush current can appear. The external switching installation must be capable of these high currents!

All standard models in this series support to run either on 380/400/480 V or also 208 V (US and Japan grids). When running a model with 30 kW power rating on 208 V it would automatically switch into derated power mode in which the available DC power is decreased to 18 kW. This is detected every time when powering the device, so that the same model could provide the full 30 kW of rated power when being run on 380/400/480 V.

2.3.5.1 AC supply requirements

No matter what particular variant the device is, standard, WC or Slave, the rated AC supply voltage on the type label is decisive. They all use a regular three-phase supply without N. Specification:

Rated DC power	Inputs on AC plug	Supply type	Configuration
10 kW / 30 kW	L1, L2, L3, (N), PE	Three-phase (3P)	Delta



The PE conductor is imperative and must always be wired to the AC plug!

2.3.5.2 Cross section

For the selection of a suitable cable **cross section** the rated AC current of the device and the cable length are decisive. Based on the connection of a **single unit** the table lists the maximum input current and recommended minimum cross section for each phase:

Available DC power	L1		L2		L3		PE ⁽¹⁾
	∅	I _{max}	∅	I _{max}	∅	I _{max}	∅
10 kW (rated)	≥10 mm ² (AWG8)	40 A	≥10 mm ² (AWG8)	40 A	≥10 mm ² (AWG8)	40 A	≥10 mm ² (AWG8)
18 kW (derated) at 208 V 30 kW (rated) at 380/400/480 V	≥10 mm ² (AWG8)	61 A	≥10 mm ² (AWG8)	61 A	≥10 mm ² (AWG8)	61 A	≥10 mm ² (AWG8)

2.3.5.3 AC plug & AC cable

The included connection plug can receive cable ends of up to 25 mm². The longer the connection cable, the higher the voltage loss due to the cable resistance. Therefore the mains cable should be kept as short as possible or have an even bigger cross section. Cables with 4 or 5 conductors can be used. When using a cable with N conductor, it's allowed to clamp it into the spare pin of the AC plug. Ratings of the AC plug:

- Max. cross section without cable end sleeve: 25 mm² (AWG4)
- Max. wire cross section with cable end sleeve: 16 mm² (AWG10)
- Stripping length without cable end sleeve: 18-20 mm (0.75 in)

¹ Valid for both, the ground conductor in the AC cable and the separate PE line for enclosure grounding

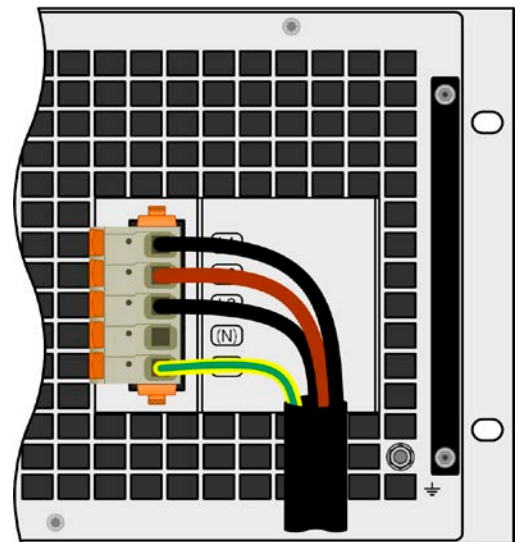
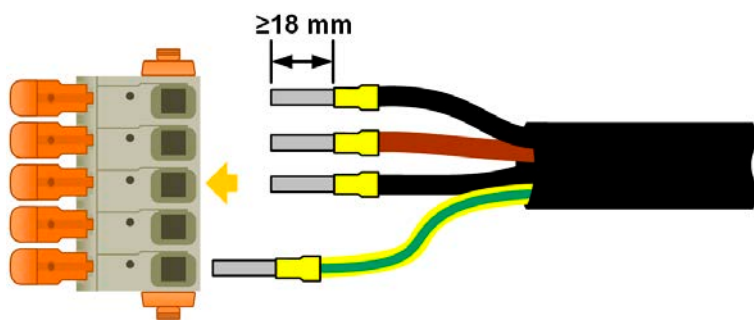

Figure 10 - Example for an AC cable with 4 conductors (european color code, cable not included in delivery)

2.3.5.4 Mounting the strain relief

All models in this series have a strain relief for the AC cable in their scope of delivery. It's recommended to be mounted and used by the installer, unless a different kind of strain relief is intended. Installation steps:

1. Remove the two screws from the AC filter box as marked in *Figure 11* below.
2. Place the bracket and fix it with the included, longer screws (M3x8) and spring/curved washers.
3. Plug the AC plug and lead the cable in front of the bracket, when seen from behind, and fix it with at least one, better both of the included cable ties.

The bracket and the cable ties can remain connected all the time. The AC plug has some space to be pulled if required. Should the device be removed from the installation (cabinet), it's recommended to only pull the plug and dismount the bracket.

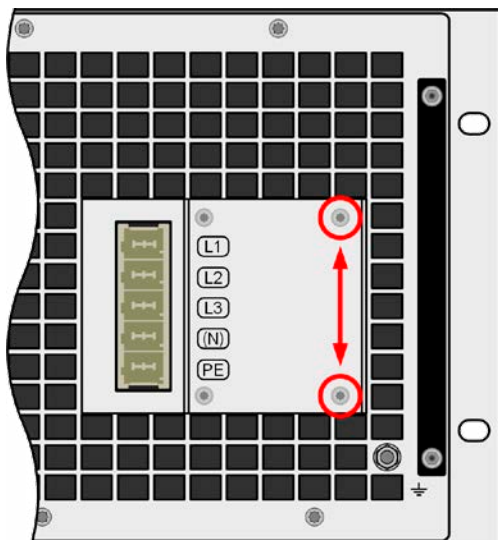

Figure 11 - Mounting position of the bracket

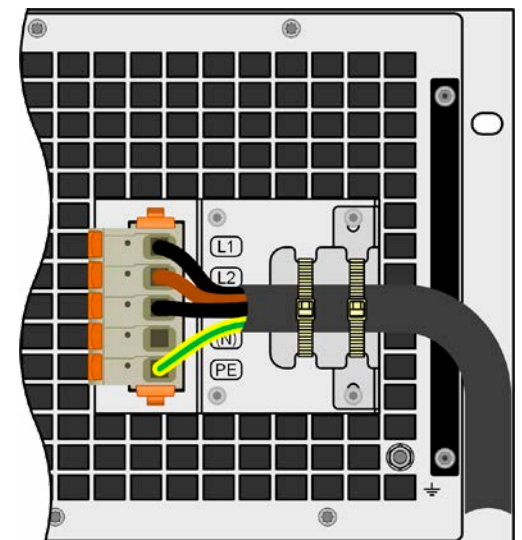

Figure 12 - Fully installed strain relief

2.3.5.5 Grounding the enclosure

The devices feature a separate grounding point on the rear side, as depicted on the figure to the right and marked as item "7" or "8" in «1.8.4 Views».

For reasons of safety for people working with the device which, amongst other measures, is achieved by keeping the leakage current as low as possible, the enclosure must be grounded. It requires a separate protective earth line (PE), being connected to the grounding point. The cross section of that line must be at least the same as with the ground conductor in the AC supply cable.

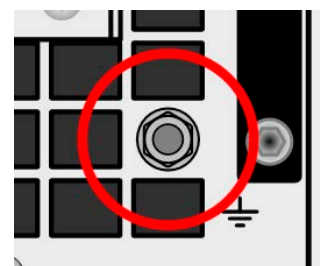

Figure 13 - Grounding point

2.3.6 Connection to DC loads or DC sources



- In the case of a device with a high nominal DC current and hence a thick and heavy DC connection cable it's necessary to take account of the weight of the cable and the strain imposed on the DC connection. Especially when mounted in a 19" cabinet or similar, where the cable could hang on the DC terminal, a strain reliever should be used.
- Besides the proper cross section of DC cables the proper electric strength (withstand voltage) of the cables must be considered.



No false polarity protection inside! When connecting sources with false polarity the device will be damaged, also when the device isn't powered!



When connected to DC, an external source charges the internal capacities on the DC terminal, even when the device isn't powered. Dangerous voltage levels can be present on the DC terminal, even after disconnection of that external source.

The DC terminal is located on the rear side of the device and is **not** protected by a fuse. The cross section of the connection cable is determined by the current consumption, cable length and ambient temperature.

For cables **up to 5 m (16.4 ft)** and average ambient temperature **up to 30°C (86°F)**, we recommend:

up to 40 A :	6 mm ² (AWG8)	up to 60 A :	16 mm ² (AWG4)
up to 80 A :	25 mm ² (AWG3)	up to 120 A :	35 mm ² (AWG1/0)
up to 180 A :	70 mm ² (AWG2/0)	up to 240 A :	2x 35 mm ² (AWG1/0)
up to 420 A :	2x 95 mm ² (AWG3/0)	up to 1000 A :	3x 185 mm ² (AWG400)

per connection pole (multi-conductor, insulated, openly suspended). Single cables of, for example, 70 mm² may be replaced by e.g. 2x 35 mm² etc. If the cables are long then the cross section must be increased to avoid voltage loss and overheating.

2.3.6.1 DC terminal types

The table below shows an overview of the various DC terminals. It's recommended that connection of DC cables always utilizes flexible cables with ring lugs.

Type 1: Models up to 200 V	Type 2: Models from 360 V
M10 bolt on a metal rail Recommendation: ring lug with a 11 mm hole	M6 bolt on a metal rail Recommendation: ring lug with a 6.5 mm hole

2.3.6.2 Cable lead and plastic cover

The scope of delivery included a plastic cover for the DC terminal which serve as contact protection. It must always be installed when operating the device. There are breakouts so that the DC cables can be laid in various directions.



The connection angle and the required bending radius for the DC cable must be taken into account when planning the depth of the complete device, especially when installing in a 19" cabinet or similar installations.

Examples for the type 1 terminal:

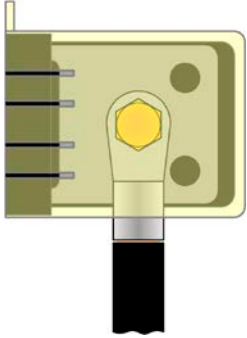

- 90° up or down
- space saving in depth
- no bending radius

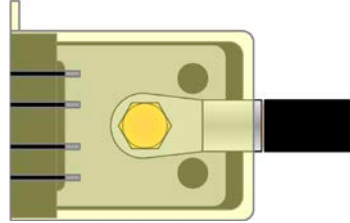

- horizontal lead
- space saving in height
- large bending radius

2.3.7 Grounding of the DC terminal

Besides the main purpose of grounding the enclosure, the extra grounding point (item "7" in 1.8.4.3 or "8" in 1.8.4.8) can be used to ground one of the DC terminal poles. Doing so causes a potential shift on the opposite pole against PE. Because of insulation, there is a maximum allowed potential shift defined for the negative DC terminal pole, which depends on the device model. Refer to «1.8.3 Specific technical data» for the levels.

Both poles on the DC terminal are floating, which is considered as a basic protection in terms of human body safety. Grounding any DC terminal voids that basic protection.



When potential shifting a model with 10 V or 60 V rating on the DC terminal, the safety extra low voltage status (SELV) can turn into a protective extra low voltage (PELV) or leave the safe range. In such a situation, the voltage levels on the DC terminal become hazardous and thus the DC terminal must be covered.



In case any DC pole is grounded, the operator of the device must reinstate the basic protection for human safety by installing appropriate external means, for instance a cover, everywhere the potential of the DC terminal is connected to.

2.3.8 Connection of remote sensing



- Remote sensing is only effective during constant voltage operation (CV) and for other regulation modes the sense input should be disconnected, if possible, because connecting it generally increases the oscillation tendency
- The cross section of the sense cables is noncritical. Recommendation for cables up to 5 m (16.4 ft): use at least 0.5 mm²
- Sense cables shouldn't be twisted, but laid close to the DC cables, i. e. Sense- cable close to DC- cable to the load etc. to damp or avoid possible oscillation. If necessary, an additional capacitor should be installed at the load/consumer to eliminate oscillation
- The Sense+ cable must be connected to DC+ on the load and Sense- to DC- at the load, otherwise the sense input of the power supply can be damaged. For an example see Figure 14 below.
- In master-slave operation, the remote sensing should be connected to the master unit only
- The dielectric strength of the sense wires must always at least match the DC voltage rating!



Dangerous voltage on the sense connectors! The sense cover must always be installed.

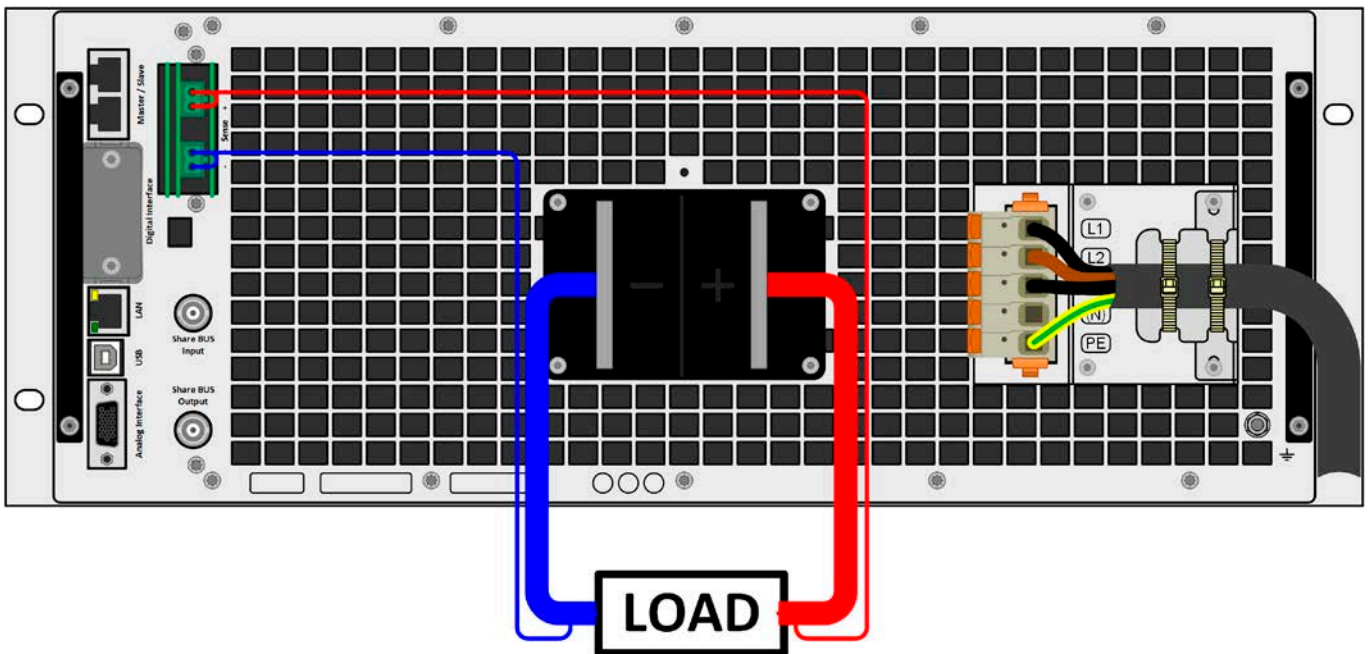
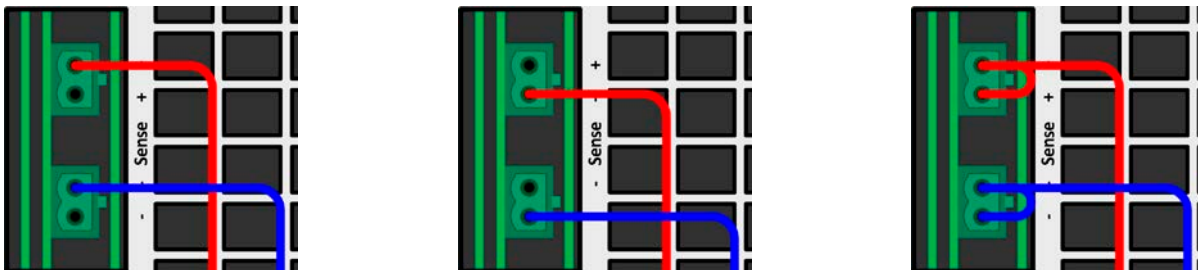

Figure 14 - Example for remote sensing wiring (DC terminal and Sense terminal covers left way for illustrative purposes)

Allowed connection schemes:



2.3.9 Installation of an interface module

The optionally obtainable interface modules can be retrofitted by the user and are exchangeable with each other. The settings for the currently installed module vary and need to be checked and, if necessary, corrected on initial installation and after module exchange.



- Common ESD protection procedures apply when inserting or exchanging a module.
- The device must be switched off before insertion or removal of a module
- Never insert any other hardware other than an interface module into the slot
- If no module is in use it's recommended that the slot cover is mounted in order to avoid internal dirtying of the device and changes in the air flow (models with air-cooling)

Installation steps:

1.

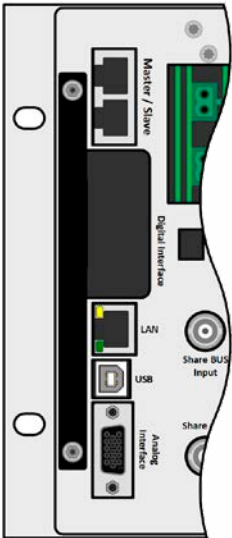

Remove the slot cover. If needed, use a screw driver.

2.

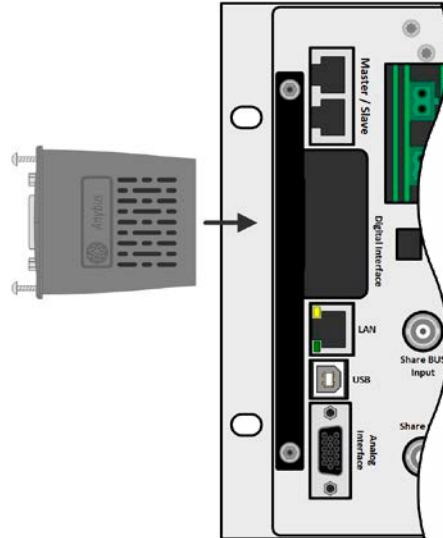

Insert the interface module into the slot. The shape ensures correct alignment.

When inserting take care that it's held as close as possible to a 90° angle to the rear wall of the device. Use the green PCB which you can recognize on the open slot as guide. At the end is a socket for the module.

On the bottom side of the module are two plastic nibs which must click into the green board (PCB) so that the module is properly aligned on the rear wall of the device.

3.

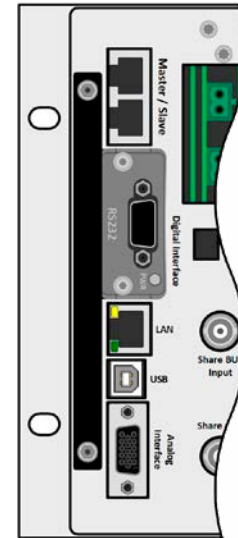

The screws (Torx 8) are provided for fixing the module and should be fully screwed in. After installation, the module is ready for use and can be connected.

Removal follows the reverse procedure. The screws can be used to assist in pulling out the module.

2.3.10 Connection of the analog interface

The 15 pole connector (type: D-sub, VGA) on the rear side is an analog interface. To connect this to a controlling hardware (PC, electronic circuit), a standard plug is necessary (not included in the scope of delivery). It's generally advisable to switch the device completely off before connecting or disconnecting this connector, but at least the DC terminal.

2.3.11 Connection of the Share bus

The "Share BUS" connectors on the rear side (2x BNC type) can be used to connect to the Share bus of further units. The main purpose of the Share bus is to balance the voltage of multiple units in parallel operation, especially when using the integrated function generator of the master unit. For further information about parallel operation refer to section «3.8.1 Parallel operation in master-slave (MS)».

For the connection of the share bus the following must be paid attention to:



- Connection is only permitted between compatible devices (see «1.9.10 "Share BUS" connector» for details) and between a max. of 64 units
- The Share bus of this series works in two directions, for source and sink mode. It's compatible to a few other device series, but it requires careful planning of the entire system, if devices are going to be connected which solely work as sink (el. load) or as source (power supply).

2.3.12 Connection of the USB port (rear side)

In order to remotely control the device via any of the two USB port (front and rear), connect the device with a PC using the included USB cable and switch the device on.

2.3.12.1 Driver installation (Windows)

On the initial connection with a PC the operating system will identify the device as new hardware and will try to install a driver. The required driver is for a Communications Device Class (CDC) device and is usually integrated in current operating systems such as Windows 7 or 10. But it's strongly recommended to use and install the included driver installer (on USB stick) to gain maximum compatibility of the device to our softwares.

2.3.12.2 Driver installation (Linux, MacOS)

We can't provide drivers or installation instructions for these operating systems. Whether a suitable driver is available is best carried out by searching the Internet.

2.3.12.3 Alternative drivers

In case the CDC drivers described above are not available on your system, or for some reason do not function correctly, commercial suppliers can help. Search the Internet for suppliers using the keywords "cdc driver windows" or "cdc driver linux" or "cdc driver macos".

2.3.13 Initial commission

For the first start-up after installation of the device, the following procedures have to be executed:

- Confirm that the connection cables to be used are of a satisfactory cross section!
- Check if the factory settings of set values, safety and monitoring functions and communication are suitable for your intended application of the device and adjust them if required, as described in the manual!
- In case of remote control via PC, read the additional documentation for interfaces and software!
- In case of remote control via the analog interface, read the section in this manual concerning analog interfaces!

2.3.14 Commission after a firmware update or a long period of non-use

In case of a firmware update, return of the equipment following repair or a location or configuration change, similar measures should be taken to those of initial start-up. Refer to «2.3.13 Initial commission».

Only after successful checking of the device as listed may it be operated as usual.

3. Operation and application

3.1 Terms

The device is a combination of a power supply and an electronic load. It can work alternately in one of two superior operation modes which are distinguished from each other in several parts of this document below:

- **Source / source mode:**
 - the device works as a power supply, generating and providing DC voltage to an external DC load
 - in this mode, the DC terminal is considered as DC output
- **Sink / sink mode:**
 - the device works as an electronic load, sinking DC energy from an external DC source
 - in this mode, the DC terminal is considered as DC input

3.2 Important notes

3.2.1 Personal safety



- In order to guarantee safety when using the device, it's essential that only persons operate the device who are fully acquainted and trained in the required safety measures to be taken when working with dangerous electrical voltages
- For models which can generate a voltage which is dangerous by contact, or is connected to such, the included DC terminal cover, or an equivalent, must always be used
- Read and follow all safety warnings in section 1.7.1!

3.2.2 General



- When running the device in source mode, unloaded operation is not considered as a normal operation mode and can thus lead to false measurements, for example when calibrating the device
- The optimal working point of the device is between 50% and 100% voltage and current
- It's recommended to not run the device below 10% voltage and current, in order to make sure technical values like ripple and transient times can be met

3.3 Operating modes

A power supply is internally controlled by different control or regulation circuits, which shall bring voltage, current and power to the adjusted values and hold them constant, if possible. These circuits follow typical laws of control systems engineering, resulting in different operating modes. Every operating mode has its own characteristics which is explained below in short form.

3.3.1 Voltage regulation / Constant voltage

Voltage regulation is also called constant voltage operation (**CV**).

The voltage on the DC terminal of the device is held constant on the adjusted value, unless the current or the power according to $P = U_{DC} \cdot I$ reaches the adjusted current or power limit. In both cases the device will automatically change to constant current or constant power operation, whatever occurs first. Then the voltage can't be held constant anymore and will sink (in source mode) or rise (in sink mode) to a value resulting from Ohm's law.

CV is available for both, sink and source mode, and primarily depends on the relation between voltage set value and voltage level on the DC terminal. The device will switch between both modes seamless when adjusting voltage. In source mode, the output voltage in CV mode is equal to the setting while in sink mode the setting must always be lower than the input voltage in order to have the device draw current.

While the DC output is switched on and constant voltage mode is active, then the condition "CV mode active" will be indicated as signal on the analog interface and can also be read as status via the digital interfaces.

3.3.1.1 Voltage regulation peaks (source mode)

When working in constant voltage regulation (CV) and source mode the device's internal voltage regulator requires a small transient time to settle the voltage after a load step. Negative load steps, i.e. high load to lower load, will cause the output voltage to overshoot for a short time until compensated by the voltage regulator. The time it takes to settle the voltage can be influenced by switching the voltage regulation speed between the settings **Slow**, **Normal** and **Fast**, whereas Normal is the default. Setting **Slow** will result in a higher transient time and higher voltage drop, but less overshooting, while **Fast** is vice versa. Also see «3.3.7 Dynamic characteristics and stability criteria».

The same occurs with a positive load step, i.e. low load to high load. There the output collapses for a moment. The amplitude of the overshoot resp. collapse depends on the device model, the currently adjusted output voltage and the capacity on the DC output and can thus not be stated with a specific value.

Depictions:

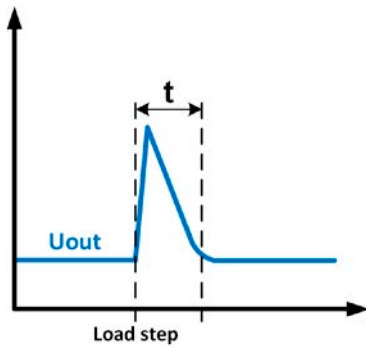

Example for a neg. load step: the DC output will rise above the adjusted value for a short time. t = transient time to settle the output voltage.

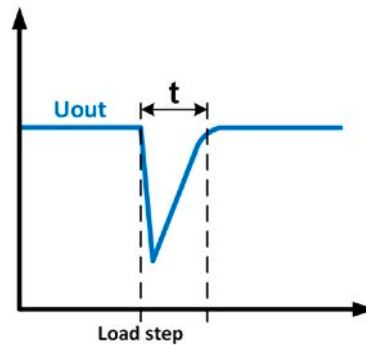

Example for a pos. load step: the DC output will collapse below the adjusted value for a short time. t = transient time to settle the output voltage.

3.3.1.2 Minimum input voltage for maximum current (sink mode)

Due to technical reasons, all models in this series have a minimum internal resistance that requires to provide a specific minimum input voltage (U_{MIN}) in order for the device to be able to sink its rated current (I_{MAX}).

This minimum input voltage varies from model to model and can easily be determined. If less voltage than U_{MIN} is supplied, the load proportionally draws less current, which can be calculated easily.

See principle view to the right.

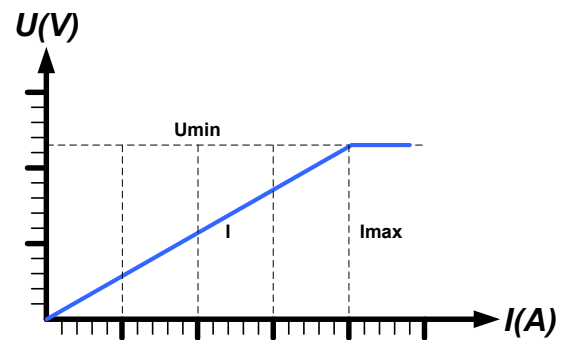

3.3.2 Current regulation / constant current / current limiting

Current regulation is also known as current limiting or constant current mode (CC).

The current in the DC terminal of the device is held constant once the output current (source mode) to the load resp. the current consumed from the load (sink mode) reaches the adjusted limit. Then the device automatically switches to CC. In source mode, the current flowing from the power supply is only determined by the output voltage and the load's true resistance. As long as the output current is lower than the adjusted current limit, the device will be either in constant voltage or constant power mode. If, however, the power consumption reaches the set maximum power value, the device will switch automatically to power limiting and set voltage and current according to $P = U * I$.

While the DC output is switched on and constant current mode is active, the condition "CC mode active" will be indicated on the front side control panel by LED "CC" and can also be read as status via the digital interfaces.

3.3.2.1 Voltage overshootings

In certain situations it's possible that the device generates a voltage overshooting. Such situations are when the device is in CC, with the actual voltage being unregulated, and either a jump in the current set value is initiated which could bring the device out of CC or when the load is suddenly cut from the power supply by an external means. Peak and duration of the overshooting aren't exactly defined, but as rule of thumb it shouldn't exceed a peak of 1-2% of the rated voltage (on top of the voltage setting), while the duration mainly depends on the charging state of the capacities on the DC output and also the capacity value.

3.3.3 Power regulation / constant power / power limiting

Power regulation, also known as power limiting or constant power (CP), keeps the DC power constant if the current flowing to the load (source mode) resp. the current from the source (sink mode) in relation to the voltage reaches the adjusted limit according to $P = U * I$ (sink mode) resp. $P = U^2 / R$ (source mode).

In source mode, the power limiter then regulates the output current according to $I = \sqrt{P / R}$, where R is the load's resistance.

Power limiting operates according to the auto-range principle such that at lower voltages higher current can flow and vice versa, always in order to maintain constant power within the range P_N (see diagram to the right).

While the DC output is switched on and constant power mode is active, the condition "CP mode active" can only be read as status via the digital interfaces.

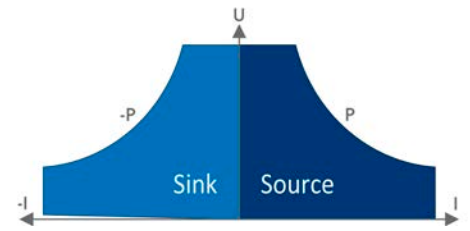

Figure 15 - Power range of 30 kW models

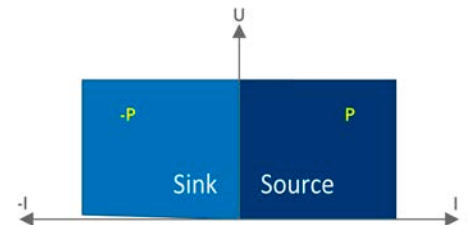

Figure 16 - Power range of the 10 kW model

3.3.3.1 Power derating (only 30 kW models)

Additionally to the default AC supply voltage, all models can also operate on a three-phase supply of 208 V (USA, Japan). In order to limit the AC current when running on this low input voltage, the 30 kW models switch to a derating mode which reduces the available DC power to 18 kW. The switchover is determined once when the device is powered and depends on the currently present AC supply voltage. It means that it cannot switch back and forth between derated and underderated mode during operation. The full power is thus only available with AC voltages from 380 V or higher.

Once derated, the device would show a permanent information in the display and all values related to the power are reduced in their adjustment range. This also applies to master-slave operation of derated units.

3.3.4 Internal resistance regulation (source mode)

Internal resistance control (abbr. CR) of power supplies is the simulation of a virtual internal resistor which is in series to the voltage source and thus also in series to the load. According to Ohm's law, this causes a voltage drop, which will result in a difference between adjusted output voltage and actual output voltage. This will work in constant current mode as well as in constant power mode, but here the output voltage will differ even more from the adjusted voltage, because then constant voltage is not active.

The voltage setting in dependency of the resistance set value and the output current is done by calculation of the microcontroller and thus will be slower the other controllers inside the control circuit. Clarification:

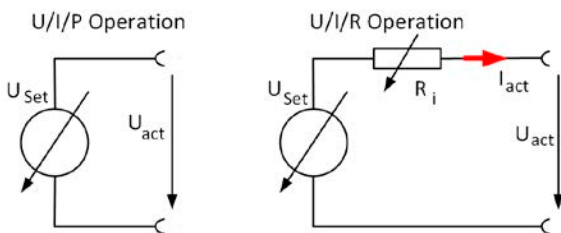

$$U_{Act} = U_{Set} - I_{Act} * R_{Set} \quad \left| \begin{matrix} P_{Set}, I_{Set} \end{matrix} \right.$$

$$P_{Ri} = (U_{Set} - U_{Act}) * I_{Act}$$



With resistance mode being activated the function generator will be unavailable and the actual power value provided by the device does not include the simulated power dissipation of Ri.

3.3.5 Resistance regulation / constant resistance (sink mode)

In sink mode, when the device is working as electronic load, the operating principle is based on a variable internal resistance. Constant resistance mode (CR) is almost a natural characteristic. The load attempts to set the internal resistance to the user defined value by determining the input current depending on the input voltage according to formula $I_{IN} = U_{IN} / R_{SET}$, which is derived from Ohm's law.

With series PUB 10000, the difference between an external voltage supplied to the device and the set value of voltage determines the true current. There are two situations:

a) The voltage on the DC terminal is higher than the voltage set value

In this situation, the above formula extends to $I_{IN} = (U_{IN} - U_{SET}) / R_{SET}$.

An example: the supplied voltage on the DC terminal is 200 V, the resistance R_{SET} is adjusted to 10 Ω and the voltage set value U_{SET} is set to 0 V. When switching the DC terminal on, the current should rise to 20 A and the actual resistance R_{MON} should show approx. as 10 Ω . When adjusting the voltage set value U_{SET} to 100 V now, the current would lower to 10 A while the actual resistance R_{MON} should remain at 10 Ω .

b) The voltage on the DC terminal is equal to or lower than the voltage set value

The PUB 10000 would not draw any current and enter CV mode. In a situation where the supplied input voltage is approx. equal to or oscillating around the voltage set value, the sink mode would permanently toggle between CV and CR. It's thus not advised to adjust the voltage set value to the same level as the external source.

The internal resistance is naturally limited between almost zero and maximum, where the resolution of current regulation becomes very inaccurate. Because the internal resistance can't have a value of zero, the lower limit is defined to an achievable minimum. This ensures that the internal electronic load, at very low input voltages, can consume a high input current from the source, up to the adjusted current set value.

While the DC terminal is switched on and constant resistance mode is active, the condition "CR mode active" can only be read via digital interface.

3.3.6 Sink-source mode switching

The switchover between sink and source mode happens automatically and only depends on the device's voltage setting and actual value on the DC terminal or the remote sense connector, if in use.

It means, that when connecting an external voltage source to the DC terminal, only the voltage set value determines the operation mode. When connecting an external load which can't generate a voltage, only source mode can be run.

Rules for applications with external voltage source connected:

- If the voltage set value is higher than the actual voltage of the external source, the device will run in source mode
- If the voltage set value is lower, it will run in sink mode

To run one of both modes explicitly, i.e. without automatic switchover, it would require following:

- for "source only mode" adjust the current set value for the sink mode to 0
- for "sink only mode" adjust the voltage set value to 0

3.3.7 Dynamic characteristics and stability criteria

When working in sink mode, the device becomes an electronic load which is characterized by short rise and fall times of the current, which are achieved by a high bandwidth of the internal regulation circuit.

In case of testing sources with own regulation circuits at the load, like for example power supplies, a regulation instability may occur. This instability is caused if the complete system (feeding source and electronic load) has too little phase and gain margin at certain frequencies. 180 ° phase shift at > 0dB amplification fulfills the condition for an oscillation and results in instability. The same can occur when using sources without own regulation circuit like batteries and when the connection cables are highly inductive or inductive-capacitive.

The instability is not caused by a malfunction of the load, but by the behavior of the complete system. An improvement of the phase and gain margin can solve this. In practice, this is primarily done by switching the internal voltage regulator between dynamics modes called **Slow**, **Fast** and **Normal**, configured using remote control and SCPI or ModBus command or in the Settings app of **EA Power Control**.

The user can only try the different settings to see if the desired effect is achieved. Should there be an improvement due to one of these settings, but the oscillation remains, an additional measure can be to install a capacity directly to the DC terminal, perhaps alternatively to the remote sense input, if connected to the source. The value to achieve the expected result is not defined and has to be found out. We recommend:

10/60/80 V models: 1000uF...4700uF

750/920/1000 V models: 22uF...100uF

200/360 V models: 100uF...470uF

1500/2000 V models: 4.7uF...22uF

500 V models: 47uF...150uF

3.4 Alarm conditions



This section only gives an overview about device alarms. What to do in case your device indicates an alarm condition is described in section «3.7 Alarms and monitoring».

Alarm conditions are those coming from the hardware of the device. As a basic principle, all alarm conditions are signaled optically (LED on the front, collection error), as a readable status via the digital interface and as signal on the analog interface (also collection error). The indication on the analog interface is by default configured to signal only OT and OVP, but can be adapted to signal the others as well, just not every single alarm. A specific alarm can only be acquired via digital interface. For acquisition and statistics of already gone alarms, an alarm counter can be read from the display or via digital interface.

3.4.1 Power Fail

Power Fail (PF) indicates an alarm condition which may have various causes:

- AC input voltage became too low during runtime (mains undervoltage, mains failure)
- Defect in the input circuit (PFC)

As soon as a power fail occurs, the device will stop to supply power and switch the DC output off. In case the power fail was an undervoltage and will be gone later on, the device can automatically continue to work as before. This depends on a setting which is either available in the Settings app of **EA Power Control** under **Other -> DC input/output state after PF alarm** or as ModBus/SCPI command. The default setting would keep the DC output switched "Off" and leave the alarm on the front panel for notification.



Powering the device down can't be distinguished from an AC supply blackout and thus the device will signalize a PF alarm every time it's actually powered down.

3.4.2 Overtemperature

An overtemperature alarm (OT) can occur from an excess temperature inside the device and temporarily causes it to switch the power stages off. This is usually due to the ambient temperature exceeding the specified operating temperature range of the device. After cooling down, the device can automatically switch the power stages back on. This is determined via a setting that can either be access in the Settings app of **EA Power Control** under **Other -> DC input/output state after OT alarm** or via ModBus/SCPI command.

3.4.3 Overvoltage protection

An overvoltage alarm (OVP) will switch off the DC power stage and can occur if:

- the device itself, when running in source mode, or an external source or load brought a voltage to the DC terminal higher than set for the overvoltage alarm threshold (OVP, 0...110% U_{Nom})
- the OVP threshold has been adjusted too close above the output voltage in source mode and if the device is in CC regulation mode and then experiences a negative load step, it will make the voltage rise quickly, resulting in a voltage overshoot for a short moment which can already trigger the OVP

This function serves to warn the user of the power supply optically (via LED "Error") and in other form that the device probably has generated an excessive voltage which could damage the connected load application.



- The device is not fitted with protection from external overvoltage and could even be damaged when not powered
- The changeover from operation modes CC -> CV in source mode can cause voltage overshoots

3.4.4 Overcurrent protection

An overcurrent alarm (OCP) will switch off the DC power stage and can occur if:

- the current in the DC terminal reaches the adjusted OCP limit.

This function serves to protect the connected load application (source mode) or the external source (sink mode) so it's not overloaded and possibly damaged due to an excessive current.

3.4.5 Overpower protection

An overpower alarm (OPP) will switch off the DC terminal and can occur if:

- the product of the voltage and current in the DC terminal reaches the adjusted OPP limit.

This function serves to protect the connected load application (source mode) or the external source (sink mode) so it's not overloaded and possibly damaged due to an excessive power.

3.4.6 Safety OVP

This extra feature is only built into the **60 V model** of this series. Similar to the regular overvoltage protection (OVP, see 3.4.3), the Safety OVP is supposed to protect the application or people according to SELV. The alarm shall prevent the device from providing an output voltage higher than 60 V. However, the alarm could also be triggered by an external source providing an excess voltage to the DC terminal of the device.

A safety OVP alarm can occur if

- the voltage on the DC of the device reaches the rigid threshold of 60.6 V.
- an external voltage of higher than 60.6 V is brought onto the device.

If the voltage on the DC output exceeds that level for any reason, the DC output, if on, will be switched off immediately and an alarm will be signaled via the alarm LED on the front panel. This alarm can't be acknowledged the usual way. It requires to power-cycle the unit.



During normal operation of the power supply, this alarm should not trigger. There are, however, situations which can trigger the alarm, like when working with voltages close to the threshold of 60.6 V or voltage spikes when leaving CC mode when the current was 0 A before.



When remote sensing is used, i. e. the rear input "Sense" is connected, the true output voltage (source mode) is higher than set value so the Safety OVP could already trigger at voltage settings lower than 60 V.

3.4.7 Share bus fail

The Share bus fail alarm (short: SF) is related to the physical Share bus (connectors on the rear side of the device) and the condition whether it's connected to at least one other device or not. The alarm is also related to the configuration of master-slave mode.

Depending on the situation, the Share bus of the involved devices must either be connected or disconnected or else the alarm might occur, preventing to switch the DC output on. Should the alarm occur in the middle of normal operation, it would switch the DC output off. Possible causes for an SF alarm:

- After powering the device and/or before initializing master-slave operation: see table below
- After master-slave initialization and in the middle of operation: physical defect of the Share bus cable

Possible situations after powering a device or after the configuration has been changed:

Master-slave mode	Share bus cable	Result	Necessary action
off	Disconnected	Normal condition outside of master-slave. Operation unrestricted.	None
off	Connected	SF alarm will occur on every unit connected on the Share bus	Remove the Share bus cable and clear the alarm
Master	Disconnected	No SF alarm on the master. The master will initialize the MS system, but if at least one slave with SF alarm has been detected, this alarm will be signaled on the master, blocking the DC output from being switched on.	Connect all devices which are supposed to be in the MS system on the Share bus and initialize the MS system
Master	Connected	There should be no SF alarm, given that only 1 master and x slaves are in the system	None
Slave	Disconnected	SF alarm occurs and can't be cleared. The master would initialize the system, but the system cannot switch DC on, because the slave reports its SF alarm to the master.	Connect all devices which are supposed to be in the MS system on the Share bus and initialize the MS system
Slave	Connected	While booting and later when the master automatically tries to initialize the MS system there should be no SF alarm on all involved devices, given that only 1 master and x slaves are in the system and all have identical firmware versions installed. In case the system is initialized only later on, the slave will signal SF.	None

3.5 Manual operation

3.5.1 Switching on the device

The device doesn't feature a power switch or something similar on the device body. It's intended for installation into a rack or cabinet that is either powered by a manual main switch or other switching equipment, such as contactors. It means, that no matter if operated as stand-alone unit or part of a master-slave system, there must always be an external power switch.

In case the device is part of a master-slave system, typically installed in a cabinet, then it's usual to power all involved units at once via a main switch. Should that be possible (topic: inrush current), then the master would wait some time for the slave(s) to finish booting and before it starts to initialize the system.

After switching on, the device indicates the boot phase with LED "Power" on the front being orange. Once it has finished booting and is ready for operation, LED "Power" would change to green.

There is a configurable option which determines the condition of the DC output after power-up. Factory setting here is "Off". Changing it to "Restore" will cause the device to restore the DC output condition from last switch-off, hence either on or off.

In master-slave operation and when the device is being slave, which is the default mode of operation for models of this series, all values and conditions are stored and restored by the master, overwriting the slaves' settings upon initialization.



For the time of the start phase the analog interface can signal undefined statuses on its digital outputs. This must be ignored until the device has finished booting and is ready to work.

3.5.2 Switching the device off

On switch-off, the last DC output condition and the most recent set values are saved. Furthermore, a PF alarm (power failure) will be signaled via LED "Error", but can be ignored.

The DC output is immediately switched off and after a short while fans will shut down and after another few seconds the device will be completely powered off.

3.5.3 Switching the DC output on or off

As long as the device isn't a slave and under remote control by a master unit or by a software via USB interface, the DC output can be manually switched on or off with the pushbutton "On / Off", as located on the front. This is for situations where the device needs to be operated stand-alone or as substitute of a failed or missing master. The same situation also allows for access to all DC output related parameters via the front USB port. The button can also be used to acknowledge device alarms signaled by LED "Error".

Configuration of parameters via one of the USB ports is considered as remote control and is thus described in 3.6.

3.6 Remote control

3.6.1 General

Remote control is essential when operating devices of this series, for example during master-slave. It's furthermore possible to take over remote via any of the built-in control interfaces (USB, analog, Anybus). One of the digital interfaces is the master-slave bus. Important here is the fact that the device can either be under remote via one of the directly accessible interfaces for users or a master unit. It means that if, for example, an attempt were to be made to switch to remote control via the digital interface whilst master-slave mode is running the device would report an error via the digital interface. In the opposite direction, the master unit could not initialize a Slave unit being in USB remote control. In both cases, however, status monitoring and reading of values via any of the USB ports is always possible.

3.6.2 Remote control via digital interface

3.6.2.1 Rear USB

The rear USB port offers the same set of commands as a PSB 10000 series device, which is considered to a standard device with its display and knobs. When accessing the PUB 10000 series device via this USB port, every feature specified for the series is available, including the option to use the device as master for any other compatible slave device.

Regarding programming and remote control the documentation "Programming guide SCPI & ModBus" is valid for the user, as well as the connected ModBus register list "Modbus_Register_PSB10000_KEx.xx+_EN.pdf".

3.6.2.2 Front USB

The main purpose of the front USB port is quick access to the most important DC output related parameters, such as set values and protections. Reading values and status is always possible, setting them only while the device isn't in control by a master device or any of the other interfaces.

Outside of master-slave, the device could be controlled remotely with software **EA Power Control** or from custom applications. In order to do so, a programming documentation is delivered with the device on USB stick.

The number of available commands is restricted on this USB port, but it supports both, SCPI and ModBus RTU communication protocols. As part of the programming documentation, there is an extra ModBus register list named Modbus_Register_PUX10000_Front_HMIx.xx+_EN.pdf.

In the programming guide there is a section for all SCPI commands supported by the various series, as supported via the rear USB port. The front USB port has a reduced set of commands, as shown below. Details about the commands and their use can be found in the programming guide.

*IDN?	SINK:POWer:LIMit:HIGH?
*CLS	SINK:POWer:PROTection[:LEVel]
*RST	SINK:POWer:PROTection[:LEVel]?
*ESE	SINK:RESistance
*ESE?	SINK:RESistance?
*ESR	SINK:RESistance:LIMit:HIGH
*STB?	SINK:RESistance:LIMit:HIGH?
MEASure:[SCALar:]CURRent[:DC]?	[SOURce:]CURRent
MEASure:[SCALar:]POWer[:DC]?	[SOURce:]CURRent?
MEASure:[SCALar:]VOLTage[:DC]?	[SOURce:]CURRent:LIMit:HIGH
OUTPut[:STATe]	[SOURce:]CURRent:LIMit:HIGH?
OUTPut[:STATe]?	[SOURce:]CURRent:LIMit:LOW
SINK:CURRent	[SOURce:]CURRent:LIMit:LOW?
SINK:CURRent?	[SOURce:]CURRent:PROTection[:LEVel]
SINK:CURRent:LIMit:HIGH	[SOURce:]CURRent:PROTection[:LEVel]?
SINK:CURRent:LIMit:HIGH?	[SOURce:]POWer
SINK:CURRent:LIMit:LOW	[SOURce:]POWer?
SINK:CURRent:LIMit:LOW?	[SOURce:]POWer:LIMit:HIGH
SINK:CURRent:PROTection[:LEVel]	[SOURce:]POWer:LIMit:HIGH?
SINK:CURRent:PROTection[:LEVel]?	[SOURce:]POWer:PROTection[:LEVel]
SINK:POWer	[SOURce:]POWer:PROTection[:LEVel]?
SINK:POWer?	[SOURce:]RESistance
SINK:POWer:LIMit:HIGH	[SOURce:]RESistance?

[SOURce:]RESistance:LIMit:HIGH	SYSTem:CONFig:UCD?
[SOURce:]RESistance:LIMit:HIGH?	SYSTem:CONFig:UCD:ACTIon
[SOURce:]VOLTage	SYSTem:CONFig:UCD:ACTIon?
[SOURce:]VOLTage?	SYSTem:CONFig:USER:TEXT
[SOURce:]VOLTage:LIMit:HIGH?	SYSTem:CONFig:USER:TEXT?
[SOURce:]VOLTage:LIMit:LOW?	SYSTem:CONFig:UVD
[SOURce:]VOLTage:PROTection[:LEVel]	SYSTem:CONFig:UVD?
[SOURce:]VOLTage:PROTection[:LEVel]?	SYSTem:CONFig:UVD:ACTIon
STATus:OPERation?	SYSTem:CONFig:UVD:ACTIon?
STATus:QUEStionable?	SYSTem:DEVIce:CLAss?
SYSTem:ALARm:ACTIon:PFAil	SYSTem:ERRor:ALL?
SYSTem:ALARm:ACTIon:PFAil?	SYSTem:ERRor:NEXt?
SYSTem:ALARm:COUNt:OCURrent?	SYSTem:ERRor?
SYSTem:ALARm:COUNt:OPOWer?	SYSTem:LOCK
SYSTem:ALARm:COUNt:OTEMperature?	SYSTem:LOCK?
SYSTem:ALARm:COUNt:OVOLTage?	SYSTem:LOCK:OWNer?
SYSTem:ALARm:COUNt:PFAil?	SYSTem:NOMinal:CURRent?
SYSTem:COMMunicate:TIMEout?	SYSTem:NOMinal:POWer?
SYSTem:CONFig:MODE	SYSTem:NOMinal:RESistance:MAXimum?
SYSTem:CONFig:MODE?	SYSTem:NOMinal:RESistance:MINimum?
SYSTem:CONFig:OCD	SYSTem:NOMinal:VOLTage?
SYSTem:CONFig:OCD?	SYSTem:SINK:ALARm:COUNt:OCURrent?
SYSTem:CONFig:OCD:ACTIon	SYSTem:SINK:ALARm:COUNt:OPOWer?
SYSTem:CONFig:OCD:ACTIon?	SYSTem:SINK:CONFig:OCD
SYSTem:CONFig:OPD	SYSTem:SINK:CONFig:OCD?
SYSTem:CONFig:OPD?	SYSTem:SINK:CONFig:OCD:ACTIon
SYSTem:CONFig:OPD:ACTIon	SYSTem:SINK:CONFig:OCD:ACTIon?
SYSTem:CONFig:OPD:ACTIon?	SYSTem:SINK:CONFig:OPD
SYSTem:CONFig:OUTPut:RESTore	SYSTem:SINK:CONFig:OPD?
SYSTem:CONFig:OUTPut:RESTore?	SYSTem:SINK:CONFig:OPD:ACTIon
SYSTem:CONFig:OVD	SYSTem:SINK:CONFig:OPD:ACTIon?
SYSTem:CONFig:OVD?	SYSTem:SINK:CONFig:UCD
SYSTem:CONFig:OVD:ACTIon	SYSTem:SINK:CONFig:UCD?
SYSTem:CONFig:OVD:ACTIon?	SYSTem:SINK:CONFig:UCD:ACTIon
SYSTem:CONFig:UCD	SYSTem:SINK:CONFig:UCD:ACTIon?

3.6.2.3 Programming

Programming details about the communication protocols etc. are to be found in the documentation “Programming Guide ModBus & SCPI” which is supplied on the included USB stick or is available as download from the manufacturer’s website.

3.6.3 Interface monitoring

Interface monitoring is a functionality with the goal to monitor (or supervise) the digital communication line between the device and a superior control unit, such as a PC or PLC, and to ensure that the device wouldn't continue working uncontrolled in case the communication line fails. A failing line can mean that it's either physically interrupted (damaged cable, bad contact, cable pulled) or the interface port inside the device hangs. The monitoring can only be configured via the Settings app of **EA Power Control**.

While monitoring is activated, it would only be valid for the one interface being used for remote control, except for the situation when the device is a slave unit within a master-slave system. Then only the master has active interface monitoring. However, the connection between master and slaves is also supervised and in case of interruption on that particular connection line or other malfunctions, the device would go into the alarm state of MSP (master-slave protection).

The monitoring is based on a user-definable timeout which would run out if not at least one message is sent to the device within the given time frame. After every message, the timeout would start again and reset with the next message coming. In case it runs out, following reaction of the device is defined:

- Exit remote control
- Should the DC output be switched on, it either switches it off or remains on, depending on what's determined by the **EA Power Control** setting **Other-> DC input/output state after remote**

Notes for the operation:

- The timeout of the monitoring can be changed anytime via remote control; the new value would only be valid after the current timeout has elapsed
- The interface monitoring doesn't deactivate the Ethernet connection timeout, so these two timeouts can overlap

3.6.4 Remote control via the analog interface

3.6.4.1 General

The galvanically isolated, 15-pole analog interface, as built-in and below referenced in short form as AI, is located on the rear side of the device offers the following possibilities:

- Remote control of current, voltage, power and resistance
- Remote status monitoring (CV, DC terminal)
- Remote alarm monitoring (OT, OVP, PF, OCP, OPP)
- Remote monitoring of actual values
- Remote on/off switching of the DC terminal

Setting the set values of voltage, current and power via the analog interface must always be done concurrently. It means, that for example the voltage can't be adjusted via the AI and current and power set by digital line, or vice versa. The internal resistance set value can additionally be adjusted.

The OVP set value and other alarm thresholds can't be set via the AI and therefore must be adapted to the given situation before the AI is taking over control. Analog set values can be supplied from an external voltage source or can be derived from the reference voltage on pin 3.

The AI can be operated in the common voltage ranges 0...5 V and 0...10 V, both representing 0...100% of the rated value. The selection of the voltage range can be done via a few settings available as ModBus register, SCPI command or in the Settings app of **EA Power Control**. The reference voltage sent out from pin 3 (VREF) will be adapted accordingly:

Selected setting **5 V**: Reference voltage = 5 V, 0...5 V set value signal for VSEL, CSEL, PSEL and RSEL correspond to 0...100% nominal value, 0...100% actual values correspond to 0...5 V at the actual value outputs CMON and VMON.

Selected setting **10 V**: Reference voltage = 10 V, 0...10 V set value signal for VSEL, CSEL, PSEL and RSEL correspond to 0...100% nominal values, 0...100% actual values correspond to 0...10 V at the actual value outputs CMON and VMON.

All set values are always additionally limited to the corresponding adjustment limits (U-max, I-max etc.), which would clip setting excess values for the DC output.

Before you begin, please read these important notes about the use of the interface:



After powering the device and during the start phase the AI signals undefined statuses on the output pins. Those must be ignored until it's ready to work.

- Analog remote control of the device must be activated by switching pin REMOTE (5) first. Only exception is pin REM-SB, which can be used independently
- Before the hardware is connected that will control the analog interface, it shall be checked that it can't provide voltage to the pins higher than specified
- Set value inputs, such as VSEL, CSEL, PSEL and RSEL (if R mode is activated), must not be left unconnected (i.e. floating) during analog remote control. In case any of the set values is not used for adjustment, it can be tied to a defined level or connected to pin VREF (solder bridge or different), so it gives 100%
- Switching between sink and source mode can only be done with the voltage level on pin VSEL. Also see example d) in 3.6.4.7.

3.6.4.2 Acknowledging device alarms

In case of a device alarm occurring during remote control via analog interface, the DC output will be switched off the same way as in digital remote control. The device would indicate an alarm (see «3.7 Alarms and monitoring») on the front with LED "Error" and also signal it on the analog interface. Which alarms are eventually signaled can be set up in the device configuration via remote control (commands or **EA Power Control**).

The alarms MSP, OVP, OCP and OPP have to be acknowledged (also see 3.7). Acknowledgment is done with pin REM-SB switching the DC output off and on again, that means a HIGH-LOW-HIGH edge (min. 50ms for LOW), given the default logical level is set for REM-SB.

The same is required for PF and OT in case the related **EA Power Control** settings **Other -> DC input/output state after PF alarm** or **Other -> DC input/output state after OT alarm** are set to **Off**.

There is one **exception**: the SOVP (Safety OVP) alarm, which is only featured with the 60 V model of this series. It can't be acknowledged and requires to power-cycle the device. It can be monitored via the analog interface and would be indicated by the alarms PF and OVP being signaled at the same time, so it would require to select the alarm indication on pin 6 to at least signal PF and for pin 14 to signal OVP in any of the combinations.

3.6.4.3 Analog interface specification

Pin	Name	Type ⁽¹⁾	Description	Default levels	Electrical specifications
1	VSEL	AI	Voltage set value	0...10 V or 0...5 V correspond to 0..100% of U_{Nom}	Accuracy 0-5 V range: < 0.4% ⁽⁵⁾ Accuracy 0-10 V range: < 0.2% ⁽⁵⁾
2	CSEL	AI	Current set value (source & sink)	0...10 V or 0...5 V correspond to 0..100% of I_{Nom}	Input impedance $R_i > 40\text{ k} \dots 100\text{ k}$
3	VREF	AO	Reference voltage	10 V or 5 V	Tolerance < 0.2% at $I_{max} = +5\text{ mA}$ Short-circuit-proof against AGND
4	DGND	POT	Ground for all digital signals		For control and status signals
5	REMOTE	DI	Switches between manual and remote control	Remote = LOW, $U_{Low} < 1\text{ V}$ Manual = HIGH, $U_{High} > 4\text{ V}$ Manual, if pin not wired	Voltage range = 0...30 V $I_{Max} = -1\text{ mA}$ at 5 V $U_{LOW\ to\ HIGH\ typ.} = 3\text{ V}$ Rec'd sender: Open collector against DGND
6	ALARMS 1	DO	Overheating /power fail alarm	Alarm = HIGH, $U_{High} > 4\text{ V}$ No alarm = LOW, $U_{Low} < 1\text{ V}$	Quasi open collector with pull-up against V_{cc} ⁽²⁾ With 5 V on the pin max. flow +1 mA $I_{Max} = -10\text{ mA}$ at $U_{CE} = 0,3\text{ V}$ $U_{Max} = 30\text{ V}$ Short-circuit-proof against DGND
7	RSEL	AI	Resistance value (source & sink)	0...10 V or 0...5 V correspond to $R_{Min} \dots R_{Max}$	Accuracy 0-5 V range: < 0.4% ⁽⁵⁾ Accuracy 0-10 V range: < 0.2% ⁽⁵⁾
8	PSEL	AI	Power set value (source & sink)	0...10 V or 0...5 V correspond to 0..100% of P_{Nom}	Input impedance $R_i > 40\text{ k} \dots 100\text{ k}$
9	VMON	AO	Actual voltage	0...10 V or 0...5 V correspond to 0..100% of U_{Nom} ⁽⁵⁾	Accuracy 0-5 V range: < 0.4% ⁽⁵⁾ Accuracy 0-10 V range: < 0.2% ⁽⁵⁾
10	CMON	AO	Actual current	0...10 V or 0...5 V correspond to 0..100% of I_{Nom} ⁽⁵⁾	$I_{Max} = +2\text{ mA}$ Short-circuit-proof against AGND
11	AGND	POT	Ground for all analog signals		For xSEL, xMON and VREF
12	R-ACTIVE	DI	R mode on / off	Off = LOW, $U_{Low} < 1\text{ V}$ On = HIGH, $U_{High} > 4\text{ V}$ On, if pin not wired	Voltage range = 0...30 V $I_{Max} = -1\text{ mA}$ at 5 V $U_{LOW\ to\ HIGH\ typ.} = 3\text{ V}$ Rec'd sender: Open collector against DGND
13	REM-SB	DI	DC terminal OFF (DC terminal ON) (ACK alarms ⁽⁴⁾)	Off = LOW, $U_{Low} < 1\text{ V}$ On = HIGH, $U_{High} > 4\text{ V}$ On, if pin not wired	Voltage range = 0...30 V $I_{Max} = +1\text{ mA}$ at 5 V Rec'd sender: Open collector against DGND
14	ALARMS 2	DO	Overvoltage alarm Overcurrent alarm Overpower alarm	Alarm = HIGH, $U_{High} > 4\text{ V}$ No alarm = LOW, $U_{Low} < 1\text{ V}$	Quasi open collector with pull-up against V_{cc} ⁽²⁾ With 5 V on the pin max. flow +1 mA $I_{Max} = -10\text{ mA}$ at $U_{CE} = 0,3\text{ V}$, $U_{Max} = 30\text{ V}$ Short-circuit-proof against DGND
15	STATUS ⁽³⁾	DO	Constant voltage regulation active DC terminal	CV = LOW, $U_{Low} < 1\text{ V}$ CC/CP/CR = HIGH, $U_{High} > 4\text{ V}$ Off = LOW, $U_{Low} < 1\text{ V}$ On = HIGH, $U_{High} > 4\text{ V}$	Short-circuit-proof against DGND

(1) AI = Analog Input, AO = Analog Output, DI = Digital Input, DO = Digital Output, POT = Potential

(2) Internal V_{cc} approx. 10 V

(3) Only one of both signals possible

(4) Only during remote control

(5) The error of a set value input adds to the general error of the related value on the DC terminal of the device

3.6.4.4 Resolution

The analog interface is internally sampled and processed by a digital micro-controller. This causes a limited resolution of analog steps. The effective resolution is the same for set values (VSEL etc.) and actual values (VMON/CMON). It's 26214 steps when working in the 10 V range. In the 5 V range this resolution halves. Due to tolerances, the truly achievable resolution can be slightly lower.

3.6.4.5 Overview of the D-sub socket

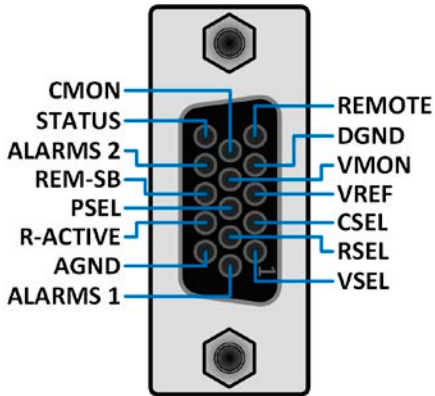

3.6.4.6 Simplified diagram of the pins

	<p>Digital Input (DI)</p> <p>It requires to use a switch with low resistance (relay, switch, circuit breaker etc.) in order to send a clean signal to the DGND.</p> <p>A digital output of an IC or PLC may not be able to pull the input down, if not of type "open collector".</p>		<p>Analog Input (AI)</p> <p>High resistance input (impedance >40 kΩ) for an operation amplifier circuit.</p>
	<p>Digital Output (DO)</p> <p>A quasi open collector, realized as high resistance pull-up against the internal supply. In condition LOW it can't drive any load, only sink small current, as shown in the diagram with a relay as example.</p>		<p>Analog Output (AO)</p> <p>Output from an operation amplifier circuit, low impedance. See specifications table above.</p>

3.6.4.7 Application examples

a) Switching the DC terminal with pin REM-SB

 A digital output, e.g. from a PLC, may be unable to cleanly pull down the pin as it may not be of sufficiently low resistance. Check the specification of the controlling application. Also see pin diagrams above.

In remote control, pin REM-SB is used to switch the DC output of the device on and off. This function is also available without remote control being active and can on the one hand block the DC output from being switched on in manual or digital remote control and on the other hand the pin can switch the DC output on or off, but not standalone. See below at **Remote control has not been activated**.

 REM-SB cannot serve as a safety stop switch to securely deactivate the DC output in case of emergency! For that an external emergency stop system is required.

It's recommended that a low resistance contact such as a switch, relay or transistor is used to switch the pin to ground (DGND).

Following situations can occur:

- Remote control has been activated**

During remote control via analog interface, only pin REM-SB determines the states of the DC output, according to the level definitions in 3.6.4.3. The logical function and the default levels can be inverted by a setting **Analog interface > REM-SB level** in the Settings app of **EA Power Control**, via ModBus register or SCPI command.

 If the pin is unconnected or the connected contact is open, the pin will be HIGH. With the setting "Analog interface -> REM-SB level" being set to "Normal", it requests to switch the DC output on. So when activating remote control, the DC output will instantly switch on.

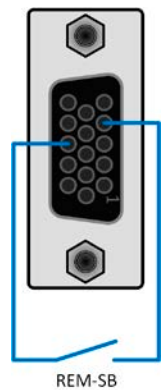

• **Remote control has not been activated**

In this mode of operation pin REM-SB can serve as lock, preventing the DC terminal from being switched on by any means. This results in following possible situations:

DC terminal	+	Level on pin REM-SB	+	Parameter „REM-SB Level“	→ Behavior
is off	+	HIGH	+	Normal	→ The DC terminal isn't locked. It can be switched on by pushbutton "On/Off" (front panel) or via command from digital interface.
		LOW	+	Inverted	
	+	HIGH	+	Inverted	→ The DC terminal is locked. It can't be switched on by pushbutton "On/Off" (front panel) or via command from digital interface. When trying to switch on, a pop-up in the display resp. an error message will be generated.
		LOW	+	Normal	

In case the DC terminal is already switched on, toggling the pin will switch the DC terminal off, similar to what it does in analog remote control:

DC terminal	+	Level on pin REM-SB	+	Parameter „REM-SB Level“	→ Behavior
is on	+	HIGH	+	Normal	→ The DC terminal remains on, nothing is locked. It can be switched on or off by pushbutton or digital command.
		LOW	+	Inverted	
	+	HIGH	+	Inverted	→ The DC output will be switched off and locked. Later it can be switched on again by toggling the pin.
		LOW	+	Normal	

b) Remote control of current and power

Requires remote control to be activated (pin REMOTE = LOW)

The set values PSEL and CSEL are generated from, for example, the reference voltage VREF, using potentiometers for each. Hence the power supply can selectively work in current limiting or power limiting mode. According to the specification of max. 5 mA load for the VREF output, potentiometers of at least 10 kΩ must be used.

The voltage set value VSEL is directly connected to VREF and will thus be permanently 100%. This also means that the device can only work in source mode. R-ACTIVE is tied to DGND, so resistance mode is off.

If the control voltage is fed in from an external source it's necessary to consider the input voltage ranges for set values (0...5 V oder 0...10 V).

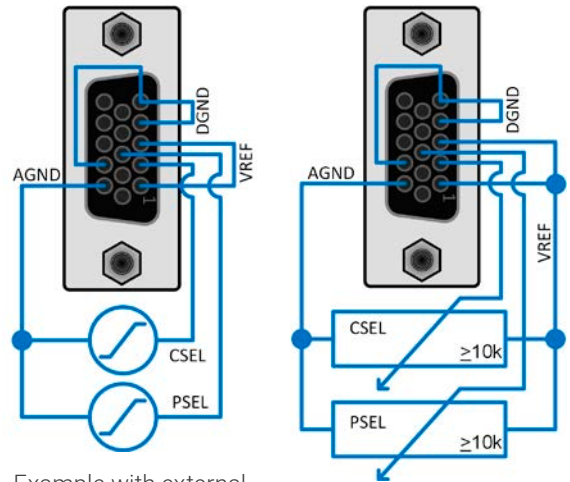

Example with external voltage source

Example with potentiometers

! When using the voltage range 0...5 V the effective resolution of set values and actual values halves.

c) Reading actual values

The AI provides the DC terminal values as current and voltage monitor. These can be read using a standard multimeter or similar.

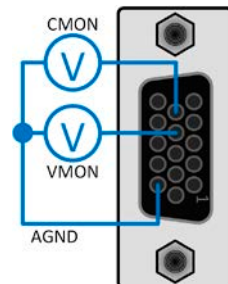

d) Switching between source and sink mode

You can also switch between both modes when remotely controlling the device with the AI. This is done using the voltage set value (VSEL), which then must not be tied to a fixed potential, like shown in example b). Rules:

- If the voltage set value on VSEL (in %, not the level) becomes higher than the actual voltage on the DC terminal, the device will switch to sink mode, no matter if the voltage on the DC terminal is generated by the device or from external
- If the voltage set value becomes lower than the actual voltage, the device will switch to source mode.

e) Determining the actual operation mode between source and sink

The limited number of pins on the AI doesn't allow for a separate signal to indicate sink or source mode. There are basically two ways to determine the actual mode:

- Compare the actual voltage output (VMON) with VSEL and also read the CMON signal -> if the level of VMON is higher than VSEL and CMON isn't zero, then the device is in sink mode, otherwise if VMON is equal to or lower than VSEL, it's in source mode, no matter what the level of CMON is
- Configure pins 9 (VMON) and 10 (CMON) either via SCPI/ModBus command or in the Settings app of **EA Power Control** under **Analog interface->VMON/CMON** to **Mode A** or **Mode B** and read both pins; when DC current is flowing in any of both directions, one of the pins will indicate with a level > 0 V.

3.7 Alarms and monitoring

3.7.1 Definition of terms

There is a clear distinction between device alarms (see «3.4 Alarm conditions»), such as overvoltage protection **OVP** or over-heating protection **OT**, and user defined events such as **OVD** (overvoltage detection). Whilst device alarms only switch the DC output off, user defined events can do more. They would also switch the DC output off with setting **Action = Alarm**, but can alternatively simply signal a warning to make the user aware. The actions driven by **user defined events** can be selected by remote control, using SCPI commands or ModBus register access. There are also configurable in the Settings app of **EA Power Control**. Following event actions are available:

Action	Impact and signaling
None	User defined event is disabled.
Signal / Warning	There is no distinction between action Signal and Warning on devices which have no display, thus here they lead to the same reaction. On reaching the condition which triggers the event, the action Signal or Warning will let the LED "Error" in the front panel blink. This status can't be read via any interface
Alarm	On reaching the condition which triggers the event, the action Alarm will let the LED "Error" on the front panel be lit steadily. Furthermore the DC output is switched off. The status can be queried via the digital interfaces.

3.7.2 Device alarm and event handling



Important to know:
When switching the DC terminal (sink mode) of the device off while a current limited source still supplies energy, the output voltage of the source can rise immediately and due to transient times the output voltage can have an overshoot to an unknown level which might trigger the overvoltage alarm (OVP) or the overvoltage supervision event (OVD) of the PSB 10000 in case these thresholds are adjusted to sensitive levels.

A device alarm incident will usually lead to DC output switch-off and be indicated via LED "Error" on the front panel and via any of the alarm pins on the analog interface, as well as stored as status readable via digital interfaces. An alarm must always be acknowledged.

► How to acknowledge an alarm on the front panel (during manual control)

1. Press button "On / Off" once to acknowledge. The LED "Error" should go out. This also means that all alarms are cleared and the DC output could be switch on by pressing the button a second time. In case the LED doesn't go out, at least one alarm is still present or a new alarm has occurred immediately after pressing the button a second time to switch DC on. This could be due to wrong supervision settings (OVP, OVD etc.).

In order to acknowledge an alarm during analog remote control refer to «3.6.4.2 Acknowledging device alarms». To acknowledge in digital remote control, refer to the external documentation "Programming Guide ModBus & SCPI".

Some device alarms are configurable, separately for source and sink mode:

Short	Long	Description	Range	Indication
OVP	OverVoltage Protection	Triggers an alarm as soon as the voltage on the DC terminal reaches the defined threshold. The DC terminal will be switched off.	$0 \text{ V} \dots 1.1 * U_{\text{Nom}}$	LED, analog & digital interfaces
OCP	OverCurrent Protection	Triggers an alarm as soon as the current in the DC terminal reaches the defined threshold. The DC terminal will be switched off.	$0 \text{ A} \dots 1.1 * I_{\text{Nom}}$	LED, analog & digital interfaces
OPP	OverPower Protection	Triggers an alarm as soon as the output or input power reaches the defined threshold. The DC terminal will be switched off.	$0 \text{ W} \dots 1.1 * P_{\text{Nom}}$	LED, analog & digital interfaces

These device alarms can't be configured and are based on hardware:

Short	Long	Description	Indication
PF	Power Fail	AC supply over- or undervoltage. Triggers an alarm in case the AC supply is out of specification or when the device is cut from AC supply. The DC output will be switched off. The condition of the DC output after a temporary PF alarm can be determined by the a setting in EA Power Control under Other->DC input/output state after PF alarm or by direct remote control command (SCPI, ModBus).	LED, analog & digital interfaces
		 <i>Acknowledging a PF alarm during runtime can only occur approx. 15 seconds after the cause of the alarm has gone. Switching the DC output on again requires another approx. 5 seconds of waiting time.</i>	
OT	OverTemperature	Triggers an alarm in case the internal temperature reaches a certain limit. The DC output will be switched off. The condition of the DC output after cooling down can be determined by a setting in EA Power Control under Other->DC input/output state after OT alarm or by direct remote control command (SCPI, ModBus).	LED, analog & digital interfaces
MSP	Master-Slave Protection	Triggers an alarm in case the master unit loses contact to any slave unit. The DC terminal will be switched off. The alarm can be cleared by reinitializing the MS system.	LED, digital interfaces
Safety OVP	Safety OverVoltage Protection	Only featured with the 60 V model: Triggers a special OVP alarm in case the voltage on the DC terminal exceeds the rigid threshold of 101% rated voltage. The DC terminal will be switched off. For details refer to section 3.4.6	LED, analog & digital interfaces
SF	Share Bus Fail	Can occur in situations where the Share bus signal is damped too much due to wrong or damaged (short-circuit) BNC cables or simply when at least one of the Share bus connectors is wired to another device while the alarm reporting one isn't configured for master-slave operation. For details also see 3.4.7.	LED, digital interfaces

3.7.2.1 User defined events

The monitoring functions of the device can be configured for user defined events. By default, events are deactivated (**Action** set to **None**). Contrary to device alarms, the events only work while the DC terminal is switched on. It means, for instance, that you can't detect undervoltage (UVD) anymore after switching the DC terminal off and the voltage would still be sinking.

The following events can be configured independently and separately for sink and source mode:

Event	Meaning	Description	Range
UVD	UnderVoltage Detection	Triggers an event if the DC voltage falls below the defined threshold.	0 V...U _{Nom}
OVD	OverVoltage Detection	Triggers an event if the DC voltage exceeds the defined threshold.	0 V...U _{Nom}
UCD	UnderCurrent Detection	Triggers an event if the DC current falls below the defined threshold.	0 A...I _{Nom}
OCD	OverCurrent Detection	Triggers an event if the DC current exceeds the defined threshold.	0 A...I _{Nom}
OPD	OverPower Detection	Triggers an event if the DC power exceeds the defined threshold.	0 W...P _{Nom}



These events shall not be confused with alarms such as OT and OVP which are for device protection. User defined events can, however, if set to action "Alarm", switch off the DC terminal and thus protect the load, like a sensitive electronic application.

3.8 Other applications

3.8.1 Parallel operation in master-slave (MS)

The primary and intended form of operation for this series is master-slave, specifically as slave.

Multiple devices of same kind can be connected in parallel in order to create a system with higher total current and hence higher power. For parallel operation in master-slave mode the units are usually connected on their DC terminals, their Share bus and their master-slave bus, which is a digital bus that makes the system work as one big unit regarding adjusted values, actual values and status.

The Share bus is intended to balance the units dynamically in their voltage on the DC terminal, i.e. in CV mode, especially if the master unit runs a dynamic function. In order for this bus to work correctly, at least the DC minus poles of all units have to be connected, because DC minus is the reference for the Share bus.

Principle view (without load or source):

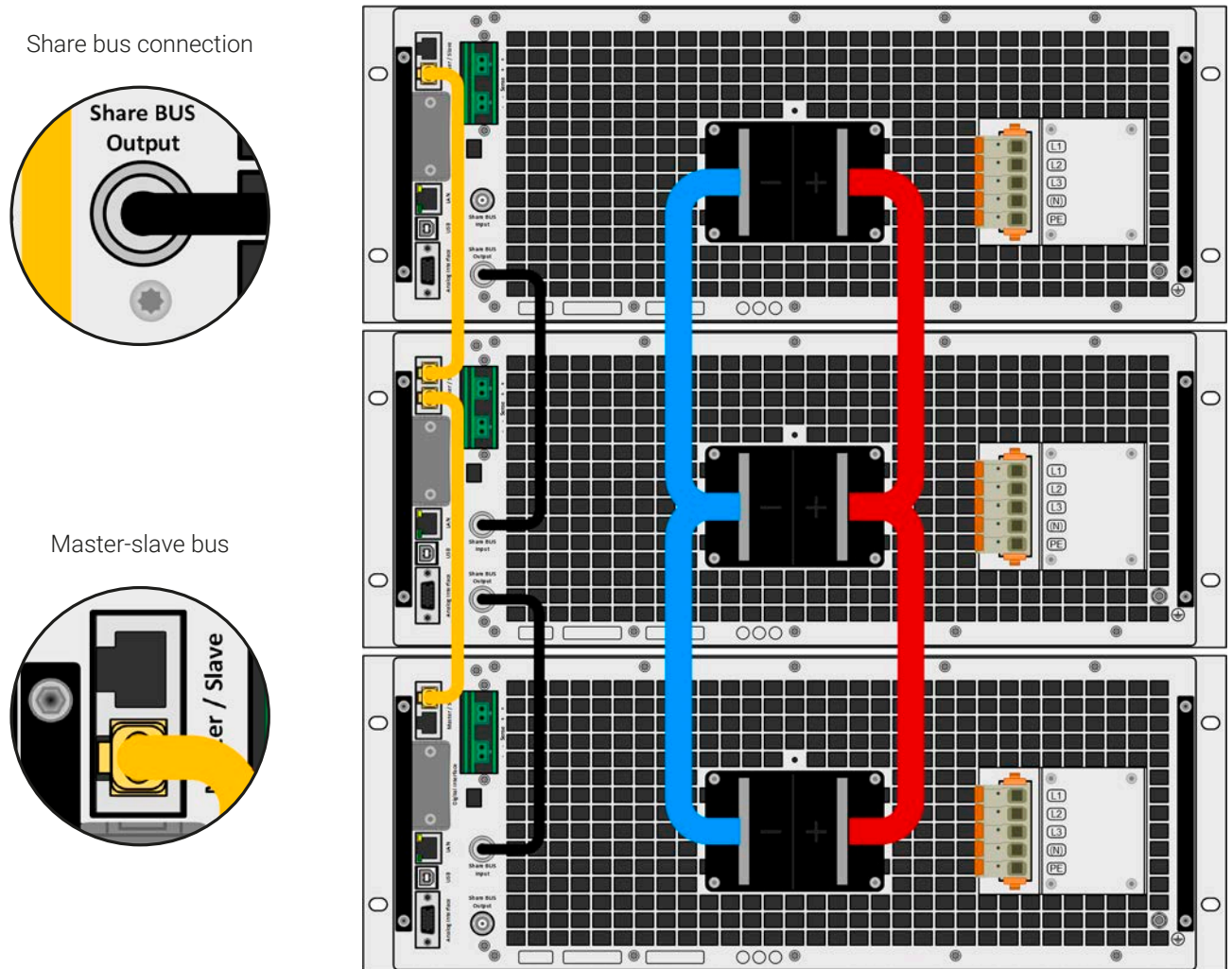

3.8.1.1 Restrictions

Compared to normal operation of a single device, master-slave operation has some restrictions:

- The MS system reacts partly different in alarm situations (see below in 3.8.1.8)
- Using the Share bus makes the system react as dynamic as possible, but it's still not as dynamic as single unit operation
- Connection to identical models from other series is supported, but limited to PSB 10000 or PSBE 10000 series

3.8.1.2 Wiring the DC terminals

The DC terminal of every unit in the parallel operation is connected with correct polarity to the next unit, using cables or copper bars with a cross section according to the total system current and with short as possible length, so their inductance is as low as possible.

3.8.1.3 Wiring the Share bus

The Share bus is wired from unit to unit with standard BNC cables (coaxial, 50 Ω type) with a length of 0.5 m (1.64 ft) or similar. Both sockets are internally connected and are not specifically input or output. The labeling is only for orientation.



- A max. of 64 units can be connected via Share bus.
- When connecting the Share bus before a device had been configured as Master or Slave, an SF alarm will occur

3.8.1.4 Wiring and set-up of the digital master-slave bus

The master-slave connectors are built-in and can be connected via network cables (≥CAT3, patch cable). After this, MS can be configured manually or by remote control. The following applies:

- A maximum of 64 units can be connected via the bus: 1 master and up to 63 slaves.
- Connection only between devices of same kind, i.e. bidirectional power supply to bidirectional power supply; connection of different power classes is allowed and supported, but with some restrictions (see section 3.8.1.5 below)
- Units at the end of the bus must be terminated (see below for more information), else the master-slave initialization will fail



The master-slave bus must not be wired using crossover cables!

Later operation of the MS system implies:

- The master unit provides summed up actual values and status of the entire system via remote control query, but not over every interface. It means, as an example, only when using SCPI a 300 kW system is capable of returning the queried actual power as “300.0kW”, but on all other interfaces this value would be a per cent value of the system’s total power and would have to be correctly translated by remote control software
- The ranges for setting the values, adjustment limits, protections (OVP etc.) and user events (UVD etc.) of the master are adapted to the total number of units. Thus, if e.g. 5 units each with a power of 30 kW are connected to a 150 kW system, then the master can be set in the range 0...150 kW.
- Slaves are no operable as long as being controlled by the master
- Slaves which haven't yet been initialized by the master will show the MSP alarm with LED “Error”. The same alarm is signaled upon MS bus errors.

3.8.1.5 Mixed systems

As mixed systems following is understood:

- Different power classes like 5 kW, 15 kW or 30 kW within one master-slave system (requires at least firmware KE 3.02)
- Different series, specifically PUB 10000 series in connection with PSB 10000 series (requires at least firmware KE 3.02)

When connecting devices with different feature sets it makes sense to select the one with the best configuration as master. Combining different power classes can have an unexpected side effect, such that the resulting total power after initialization isn't the expected one, but lower. This depends on what unit with what power class has been picked as master. In such a situation the golden rule is: always select the master from within the units with the highest power rating.

Example: you want to connect a 30 kW unit and a 3kW unit in order to achieve 33 kW. Generally, the voltage rating must match, but current and power rating can be different. The power rating then is decisive. When using the 3 kW unit as master, the total system power will only be 28 kW, which is even less than the single 30 kW unit can provide. However, when switching to the 30 kW unit as master, the system will result in 33 kW total power.

Compatibility of 10000 series to each other, no matter what power class (date 03-2023):

	PS	PSI	PU	ELR	PUL	PSB	PSBE	PUB
PS	x	x	x (*)	-	-	-	-	-
PSI	x	x	x (*)	-	-	-	-	-
PU	x (*)	x (*)	x (*)	-	-	-	-	-
ELR	-	-	-	x	x (*)	-	-	-
PUL	-	-	-	x (*)	x (*)	-	-	-
PSB	-	-	-	-	-	x	x	x (*)
PSBE	-	-	-	-	-	x	x	x (*)
PUB	-	-	-	-	-	x (*)	x (*)	x (*)

(* Requires at least firmware KE 3.06 on all involved units)

3.8.1.6 Configuring the master-slave operation

Master-slave configuration for a system that shall not be changed anymore afterwards, has to be done only once. The devices will store their settings and after every start the master will automatically try to initialize all slaves. Should the master be one with a display, configuration and initialization can be done manually, using the touch screen.

Otherwise, the setup is done either via custom software and ModBus/SCPI commands or **EA Power Control**. Given that the master-slave system is already properly wired and all units are running, the last step is master-slave configuration.

► How to configure a unit as slave or master for master-slave operation using EA Power Control

1. Connect the device to the PC using either the front USB or rear USB port
2. Start **EA Power Control** and let it find the device. In case, several devices are connected to the PC, select the proper one and drag its symbol onto the **Settings** app.
3. In the Settings app, navigate to group **Master-slave** and set **Master-slave mode** to **Slave** or **Master**.
4. Correctly set termination. The actual bus termination is done with internal electronic switches which are controlled via commands. This can be done as part of setting up every unit as master or slave, but should be done before the master is going to be set as such, because doing so immediately triggers a bus initialization. In the settings group **Master-slave** the termination resistors for BIAS and for the bus itself (TERM, see figure to the right) can be set separately. Termination setting for the units on the MS bus:

Device position	Termination setting(s)
Master (at end of bus)	Bias resistor = On + Termination resistor = On
Master (central in bus)	Bias resistor = On
Slave (at end of bus)	Termination resistor = On
Slave (central in bus)	Bias resistor = Off + Termination resistor = Off

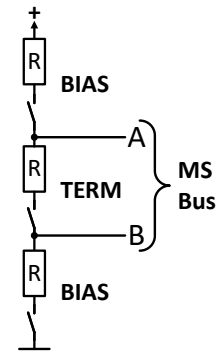

5. Save settings and leave the app.



As long as MS mode remains activated, the initialization process of the master-slave system will be repeated each time the master unit is powered. The initialization can also be repeated manually anytime via the Settings app in EA Power Control, in group "Master-Slave", or custom software using master-slave operation related commands.

3.8.1.7 Operating the master-slave system

After successful configuration and initialization of the master and slave units, the focus is on the master. In case the master is a model from this series, it cannot show its master status on the front via LEDs, but the status of the MS operation can be queried anytime from the master using **EA Power Control** or custom software. Masters with display can show all status on the display as well.

From now on the slaves can no longer be controlled manually or remotely, neither via the analog nor via digital interfaces. If needed, they could be monitored via these interfaces by reading actual values and status.

The master unit will reconfigure after initialization and all set values are reset. Towards a controlling software, the master can represent all its values in readable form and adapted to what the system now is defined for, but only when using SCPI or perhaps LabVIEW, which limits the choice of interfaces to LAN or USB. Depending on the number of units, the adjustable current and power range will multiply, while the resistance range will decrease. With any of the other available interfaces, the translation of values is to be done by the software. Following applies generally:

- The system, represented by the master, can be treated like a standalone unit
- The master shares the set values etc. across the slaves and controls them
- The master is remotely controllable via the analog or digital interfaces
- All settings for the set values U, I, P and R on the master, plus also all related values from supervision, limits etc. should be adapted to the new total values
- All initialized slaves will reset any limits (U_{Min} , I_{Max} etc.), supervision thresholds (OVP, OPP etc.) and event settings (UCD, OVD etc.) to default values, so these don't interfere the control by the master. As soon as these values are modified on the master, they are transferred 1:1 to the slaves. Later, during operation, it might occur that a slave causes an alarm or an event earlier than the master, due to imbalanced current or slightly faster reaction.
- If one or more slaves report a device alarm, it will also be signaled on the master via LED "Error" and must be acknowledged on the master, no matter with what of the available ways, so that the slave(s) can continue operation. Since an alarm usually causes the DC outputs to switch off and can only reinstate the on/off condition automatically after PF or OT alarms, where the reaction to the alarms is configurable, action from an operator or a remote control software may become necessary in such a situation.

- Loss of connection to any slave will result in shutdown of all DC outputs as a safety measure and the units will report this situation on their front panels by the LED "Error" lighting up, as well as master will provide a readable alarm status MSP ("master-slave protection"). Then the MS system has to be re-initialized, either with or without prior re-establishment of the connection to the disconnected unit(s).
- All units, even the slaves, can be externally shut down on their DC terminals using the pin REM-SB of the analog interface. This can be used as some kind of "emergency off", here usually a contact (maker or breaker) is wired to this pin on all units in parallel.

3.8.1.8 Alarms and other problem situations

Master-slave operation, due to the connection of multiple units and their interaction, can cause additional problem situations which do not occur when operating individual units. For such occurrences the following regulations have been defined:

- Generally, if the master loses connection to any slave, it will generate an MSP (master-slave protection) alarm, pop up a message on the screen (if the master is one with display) and switch off its DC output. The slaves will fall back to single operation mode, but also switch off their DC output. The MSP alarm can be deleted by either initializing the master-slave system again or deactivating master-slave mode which requires to connect to every single slave. Re-initialization can either be done in the MSP alarm pop-up screen (if the master is with display) or in the MENU of the master (if the master is with display) or via remote control.
- If one or more slave units are cut from AC supply (blackout, supply undervoltage) and come back later, they're not automatically initialized and included again in the MS system. Then the init has to be repeated.
- If the master unit is cut from AC supply (fuse tripped, blackout) and comes back later, it will automatically try to initialize the MS system again, finding and integrating all active slaves. In such a case, MS can be restored automatically.
- If accidentally multiple or no units are defined as master the master-slave system can't be initialized
- Should the master report the initialization status as failed and the status message says "Different firmwares or models detected" (if the master is with display), then at least one unit in the MS system either has an older hardware version or there are different firmware versions installed in the units. The latter can be fixed by checking what's installed on the units and then adapt.

In situations where one or multiple units generate a device alarm like OVP etc. following applies:

- Any alarm of a slave is indicated on the slave's front panel and on the master's front panel (with or without display)
- If multiple alarms happen simultaneously, the master only indicates the most recent one. In this case, the particular alarms could be read from the slave units via digital interface.
- All units in the MS system supervise their own values regarding overvoltage, overcurrent and overpower and in case of alarm they report the alarm to the master. In situations where the current is probably not balanced between the units, it can occur that one unit generates an OCP alarm though the global OCP limit of the MS system was not reached. The same can occur with the OPP alarm.

3.8.2 Series connection



Besides being able to work as a power supply, the device is also an electronic load.
Series connection in sink mode operation isn't supported and must thus not be connected and operated (can void warranty)!
Series connection in source mode operation only at one's own risk (can void warranty)!

Series connection in source mode operation is possible, but requires extra measures to ensure the device cannot enter sink mode. This is achieved by setting the power and current set values for sink mode to zero.

There is furthermore a technical limit of the achievable total voltage which depends on the strength of insulation of the DC plus and DC minus poles, as given in the technical specifications in 1.8.3. These specifications determine how many units with the same or different voltage rating can be operated in series and in case there are different models, it also determines which model can be in what position.

Basic rule: when connecting models with different voltage ratings in series, their current and power ratings are usually also different which result in a global current and power limit of the series that is defined by the unit with the smallest current or power rating.

3.8.3 SEMI F47

SEMI F47 (the SEMI comes from semiconductor) is a specification that demands a device to continue working without interruption in case of a power failure in form of an AC supply undervoltage (here: sag) of max. -50% of the rated line voltage with a max. duration of 1.7 seconds. PUB 10000 series devices have this feature by default, but when running in connection with older units with display being the master of a master-slave system, usually a PSB 10000, it may not yet have this feature. It can be retrofitted, but not by just installing an update.

SEMI F47 specifies a AC supply voltage sag in steps of increasing voltage:

Sag of	Duration at 50 Hz	Duration at 60 Hz	Duration in seconds
50%	10 cycles	12 cycles	0.2
30%	25 cycles	30 cycles	0.5
20%	50 cycles	60 cycles	1 s

3.8.3.1 Restrictions

- The feature will be disabled automatically and also locked if the device boots with low AC supply voltage present, i. e. 208 V (L-L) instead of the default 400 V (L-L), so it could not bridge the 1.7 s duration of the F47 pulse anymore. It means that SEMI F47 isn't available while derating is active.
- It requires a decreased max. power, compared to the rated power of the particular model, thus SEMI F47 is also a sort of derating, but it's not depending on the line voltage but what the AC input circuit (PFC) can cover without running into a power fail. This reduced power rating is activated and deactivated together with SEMI F47

3.8.3.2 Adjustments

SEMI F47 can be activated/deactivated only via digital interface and only in software **EA Power Control**, unless blocked due to the current device state.

3.8.3.3 Application

The feature can be activated at any time, unless blocked for the current device, for example when low voltage derating is already active (see 3.3.3.7). When activating it during normal operation, the device will instantly reduce the max. available power, as well as adapt the power set values, should the adjusted ones be higher than the new maximum. When deactivating the feature it works vice versa, only the power set values remain unaltered then. Due to the fact that the setting is stored beyond shutting down the device, it could directly boot into SEMI F47 mode during next start. In case of PUB 10000 this isn't indicated at all on the control panel, so it looks like if the device has booted normally. The status can, however, be read via any digital interface.

If later a voltage sag occurs, the level of sag or the duration decides whether the device continues its operation without switching the DC output off or it would show a **PF** alarm via LED "Error". Without SEMI F47 being activated, the PF alarm would appear immediately while with activated SEMI F47 it's delayed for at least 2 seconds or will never occur. In this case, the device wouldn't show any reaction to the sag, nor register the occurrence in any form.

4. Service and maintenance

4.1 Maintenance / cleaning

The device needs no recurring maintenance. Cleaning may be needed for the internal fans, the frequency of cleanse is depending on the ambient conditions. The fans serve to cool the components which are heated by the inherent power loss. Heavily dirt filled fans can lead to insufficient airflow and therefore the DC terminal would switch off too early due to over-heating or possibly lead to defects.

In case there is requirement for such a maintenance, please contact us.

4.1.1 Battery replacement

The device contains a Lithium cell battery of type CR2032, which is placed on the so-called KE board that is mounted to the right-hand side wall (when looking from the front) of the device. The battery is specified for a life span of at least 5 years, but due to ambient condition, especially temperature, this span could be lower. The battery is used to buffer the internal real-time clock and if it becomes necessary to replace the battery, it can be done on location by a qualified person while maintaining typical ESD precautionary measures. The KE board would have to be loosened and lifted up carefully to access the battery.

4.2 Fault finding / diagnosis / repair

If the equipment suddenly performs in an unexpected way, which indicates a fault, or it has an obvious defect, this can't and must not be repaired by the user. Contact the supplier in case of suspicion and elicit the steps to be taken.

It will then usually be necessary to return the device to the supplier (with or without guarantee). If a return for checking or repair is to be carried out, ensure that:

- the supplier has been contacted and it's clarified how and where the equipment should be sent.
- the device is in fully assembled state and in suitable transport packaging, ideally the original packaging.
- optional extras such as an interface module is included if this is in any way connected to the problem.
- a fault description in as much detail as possible is attached.
- if shipping destination is abroad, the necessary customs papers are attached.

4.2.1 Firmware updates



Firmware updates should only be installed when they can eliminate existing bugs in the firmware in the device or contain new features.

The firmware of the control panel (HMI), of the communication unit (KE) and the digital controller (DR), if necessary, is updated via the rear side USB port. For this the software EA Power Control is needed which is included with the device or available as download from our website together with the firmware update, or upon request.

However, be advised not to install updates promptly. Every update includes the risk of an inoperable device or system. We recommend to install updates only if...

- an imminent problem with your device can directly be solved, especially if we suggested to install an update during a support case
- a new feature has been added which you definitely want to use. In this case, the full responsibility is transferred to you.

Following also applies in connection with firmware updates:

- Simple changes in firmwares can have crucial effects on the application the devices are use in. We thus recommend to study the list of changes in the firmware history very thoroughly.
- Newly implemented features may require an updated documentation (user manual and/or programming guide, as well as LabVIEW VIs), which is often delivered only later, sometimes significantly later

4.2.2 Trouble-shooting device problems

Problem situation	Possible hazard	Probability	Safety measures to take by the operator	Residual risk
A voltage source with reversed polarity has been connected to the DC terminal	Damage of the internal secondary power stage	Low	With all application that require to connect an external source to the device, especially if the source is a battery, attach an extra warning sign onto the device which instructs the user to be extra careful, watching the polarity. As an additional measure include fuses in line with the DC cables which could attenuate or even prevent damage to the device.	Low

5. Contact and support

5.1 Repairs/Technical support

Repairs, unless otherwise agreed between the user and the supplier, will be carried out by the manufacturer. For this purpose, the device must be sent to the manufacturer. In order to ensure a fast and smooth handling of a support request or a repair, we kindly ask you to visit the support section of our website at www.elektroautomatik.com/en/service in the first step, and submit your support or repair request by filling out the respective form field ("Support Request" or "Repair Request"). Without this data input, no service order can be generated.

5.2 Contact options

Questions or problems with operation of the device, use of optional components, with the documentation or software, can be addressed to technical support either by telephone or e-Mail.

Headquarter	eMail addresses	Telephone
EA Elektro-Automatik GmbH Helmholtzstr. 31-37 41747 Viersen Germany	Technical support: support@elektroautomatik.com All other topics: ea1974@elektroautomatik.com	Switchboard: +49 2162 / 37850 Support: +49 2162 / 378566

EA Elektro-Automatik GmbH & Co. KG

Helmholtzstr. 31-37
41747 Viersen

Phone: +49 (2162) 3785 - 0
Fax: +49 (2162) 16230
ea1974@elektroautomatik.com

www.elektroautomatik.com

EA Elektro-Automatik Inc.

7926 Convoy Court
CA, 92111, San Diego

Phone: +1 (858) 836 1300
sales@elektroautomatik.com

www.eapowered.com

